

## Solutions

The final piece in your puzzle -  
a diverse offering of adhesives,  
sealants and specialty RTV silicone rubber



# Contents

RTV Overview .....	3-5
Industry/Application Overview .....	6-7
Product Details	
One-Part Condensation Cure	
Acetoxy Cure Chemistry .....	8-9
Neutral Cure Chemistry (Alkoxy and Modified Alkoxy) .....	10-13
Oxime Series .....	14-15
Two-Part Condensation Cure (Alkoxy) .....	16-18
Two-Part Condensation Cure: Catalyst Options .....	19
One-Part Addition Cure .....	20-21
Two-Part Addition Cure .....	22-23
Thermally Conductive Adhesives and Sealants .....	24-25
Thermally Conductive Greases .....	26
Semiconductor Die-Attach Adhesives and Encapsulants .....	26
Gels .....	28-29
InvisiSil* LED and Optoelectronics Encapsulants .....	30
Silicone Liquid Elastomers (SLE) .....	30-31
Foams and Foamable Products .....	32-33
Mold Making Products .....	34-37
Mold Making Accessory Products .....	34-35
Surface Preparation and Adhesion .....	38
Primers .....	39
Tables: Low Volatility Grades, UL Recognition, Food Contact Applications (FDA, USDA, NSF Compliant), Standard Methyl Silicone Chemical Resistance .....	40-43
FAQ's .....	44-45
Product Selector Guide for Quick Referencing .....	46-50
What Momentive Can Do for You .....	51

# RTV Overview

## R

## T

## V

### One-part

#### Versatile Technology

One-part silicone adhesives and sealants from Momentive require no mixing, utilize either atmospheric moisture or heat to cure, and offer primerless adhesion to many substrates.

#### Addition Cure or Heat-Accelerated Cure

Momentive produces a full range of one-part materials, each with distinct customer benefits. Many one-part silicone adhesives and sealants are excellent candidates to consider for assembly applications near sensitive electrical or electronic components. Heat-accelerated or addition cure silicones offer very fast cure, have virtually no shrinkage and no corrosive by-products.

#### Dispensing System Productivity

One-part products can be precisely dispensed with automated or manual equipment as:

- Formed-in-place gaskets
- Sealants
- Structural adhesives
- Protective coatings

#### Major Industry Segments:

- Appliances
- Automotive
- Commercial aircraft
- Communications
- Mass transit
- Industrial maintenance & repair
- RV's

RTV silicones consist of rubber and gel products developed for adhesion, sealing, coating and encapsulation/potting applications. Momentive offers an extensive line-up of RTVs to serve a broad spectrum of Industrial and Electronic applications.

### Two-part

#### Electronic Specialties

Widely used in electronics, silicone encapsulants from Momentive are primarily two-part materials, which utilize atmospheric moisture or heat to initiate cure. These products are generally compatible with most electronic devices and can offer superior mechanical and environmental protection.

#### Custom Technologies

Momentive two-part silicones have no corrosive cure by-products. They are available in a wide range of cure speeds and viscosities. Products are available that offer enhancements for extra thermal cycling protection, optical clarity and strength. Momentive two-part adhesives and encapsulants offer innovative solutions to the challenges of protecting high performance electronic components, wherever they are used.

#### Major Industry Segments:

- Appliances
- Automotive
- Computers & business equipment
- Commercial aircraft
- Telecommunications
- Mass transit



One-Part



Two-Part

## RTV Silicone Profile

RTV silicones consist of Condensation Cure and Addition (heat) Cure grades. Selection of the appropriate type of RTV depends upon the required manufacturing process, handling requirements, curing conditions, equipment and desired material properties.

- **Condensation Cure RTV:** Cure to form an elastic silicone rubber when exposed to moisture in the environment at room temperature. One-part RTVs are categorized into acetoxy, alkoxy, modified alkoxy (methoxy) or oxime based upon the by-products that form during cure.
- **Addition (heat) Cure RTV:** Cure to form an elastic silicone rubber when exposed to elevated heat or room temperature.

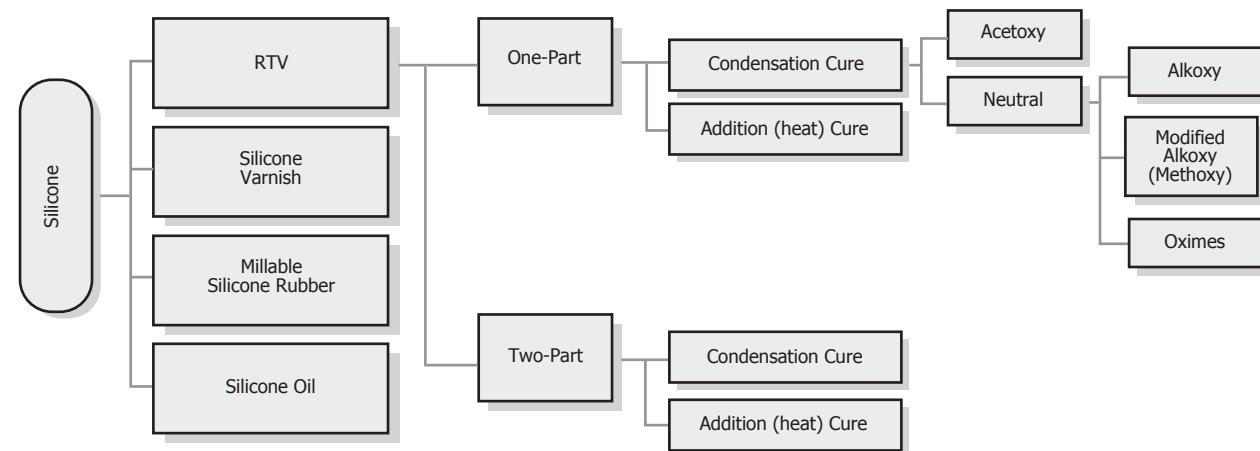

## Adhesive Sealant Cure Systems

### Application Performance Guide

	Cure Systems				
	Acetoxy	Alkoxy	Modified Alkoxy	Oxime	Addition (Heat)
By-Product	Acetic Acid	Alcohol	Ammonia, Alcohol	Methylethylketoxime	None
<b>Non-Corrosive</b>	<b>No</b>	<b>Yes</b>	<b>Yes<sup>(a)</sup></b>	<b>Yes</b>	<b>Yes</b>
Substrates for Good Adhesion	Glass, Metals	Plastics, Glass	Plastics, Glass	Metals, Glass, Some Plastics	Metals, Glass, Some Plastics
<b>Odor</b>	<b>Yes</b>	<b>Low</b>	<b>Low</b>	<b>Low</b>	<b>None</b>
Tack Free Time	Fast	Moderate	Moderate	Moderate	Very Fast
<b>Cure Rate</b>	<b>Fast</b>	<b>Slow</b>	<b>Moderate</b>	<b>Fast</b>	<b>Very Fast</b>

All data suggested @ 77°F, 55% RH

While all silicone sealants chemically bond to glass and most metals, specific cure chemistries were developed to optimize adhesion to other key substrates such as plastics and certain metal alloys. For more information on adhesion, please refer to page 38.

<sup>(a)</sup> When allowed to cure in enclosed conditions, these sealants may discolor sensitive metals with which they come into direct contact with.

## RTV Consistencies

**Industry Silicones Range from Thixotropic Pastes to Very Thin Viscosity Flowables**  
(Momentive does not offer solvent type RTVs)



### Application Geometry and Cure Chemistry Options

The shape and conditions of the part are important in selecting a suitable RTV silicone grade for each application. While one-part condensation cure grades offer the convenience of a one component material without the need for heating equipment, their cure chemistry is dependent on exposure to atmospheric moisture. The following are some general guidelines:

#### Shallow Cavity / Small Mass

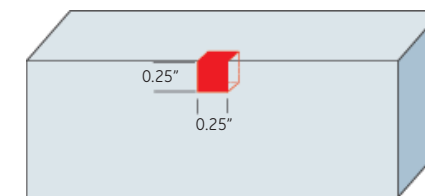

Selection Options:

- One-part Condensation Cure
- One-part Addition Cure
- Two-part Condensation Cure
- Two-part Addition Cure

#### Complex Design – Exposed Surface

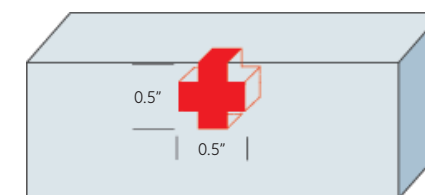

Selection Options:

- One-part Addition Cure
- Two-part Condensation Cure
- Two-part Addition Cure

#### Deep Cavity / Large Mass

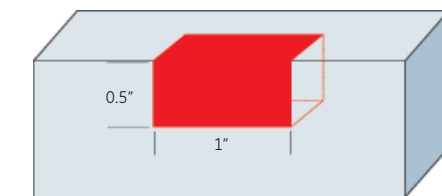

Selection Options:

- One-part Addition Cure
- Two-part Condensation Cure
- Two-part Addition Cure

#### Enclosed System

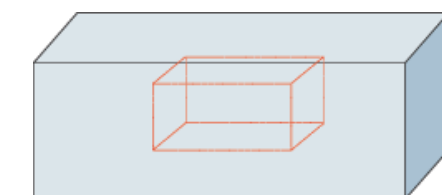

Selection Options:

- One-part Addition Cure
- Two-part Addition Cure



# Industries/Applications

## Aviation and Aerospace

Electronic component and frame assembly needs in the Aerospace Industry are served through RTV adhesives, potting, coating, encapsulation and sealing materials that withstand stress and temperature extremes.

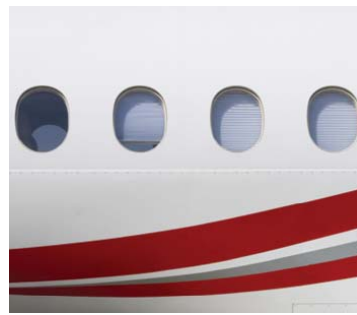

### Typical Applications:

- Cockpit Instruments
- Electronic Power Equipment
- Circuit and Terminal Protection
- Wire Sealants
- Engine Gasketing
- Engine Electronics Potting
- Cargo Door Seals
- Window Assembly Sealants
- Weather Strip Adhesive
- Lighting Sealants
- Ventilation Ducts
- General Maintenance

## Automotive

The Automotive Industry plays a critical role in integrating new electronic technologies. As more and more components migrate to electronic solutions, RTVs play an increasingly vital role in delivering material solutions to provide design flexibility, protection and long term component reliability under harsh operating conditions.



### Typical Applications:

- ECU Potting, Sealing, Coating
- Wire Connector Potting
- Alternator Voltage Regulators
- Actuators
- HVAC Systems
- Sensor Potting, Sealing
- Air Flow Meters
- Pressure Sensors
- Temperature Sensors
- Rotation Sensors
- Ultrasonic Sensors
- Headlamp Seals
- LED Lamp Potting
- Airbag Coating
- Engine FIPG

# Industries/Applications

## Consumer Goods

RTVs are commonly used in a wide variety of consumer goods and home appliance products. In addition to strong adhesion performance to many substrates, silicones can provide heat resistance, flame retardancy, and moisture/dirt protection, which makes silicones ideal materials for a variety of sealing, bonding and insulation applications.



### Typical Applications:

- Flat Panel Display Sealing
- CRT Wedges, Bases, Anodes
- Microwave Oven Doors, Box Sealing
- Steam Iron Plate Seals
- Air Conditioner Units
- Gas Stoves
- Heaters, Ovens
- Control Panel Insulation
- PCB Fixing & Sealing

## Consumer Electronics and Microelectronics

RTVs are used extensively in the Electronic and Electric industries to ensure long-term, reliable performance of critical components and electronic circuit assemblies. Silicone adhesives, sealants, conformal coatings, potting gels, encapsulants and thermal management materials play a vital role in many of today's demanding electronic applications.

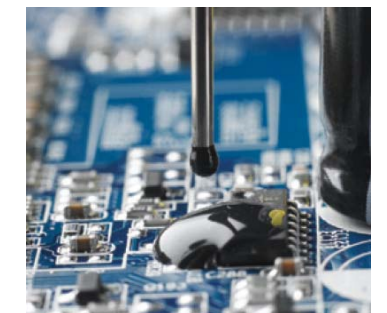
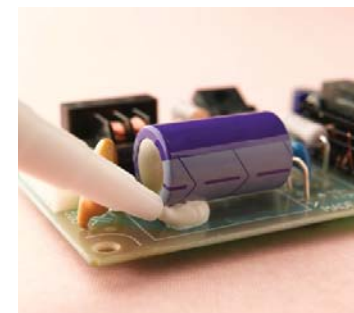
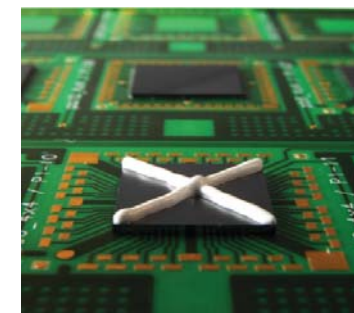

### Typical Applications:

- Power Modules
- Converters
- Solar Cells
- Hybrid ICs
- Micro-Electronics
- PCB Fixing & Sealing
- High Voltage Part Insulation
- Sensors
- Membrane Switches
- LEDs
- Photo Couplers

One-Part Condensation Cure: Acetoxy Cure Chemistry<sup>+</sup>

	HIGH PERFORMANCE						SPECIALTY		GENERAL PURPOSE	
			HIGH STRENGTH							
	RTV100 Series	RTV106	RTV112 RTV118	RTV116	RTV157	RTV159	FRV1106	RTV1473	IS800 Series <sup>(1)</sup>	IS806
<b>Features</b>	Paste adhesive with FDA, USDA, NSF. UL listed. MIL-A-46106B.	High temperature, paste adhesive compliant with FDA, USDA and NSF. UL listed. MIL-A-46106B.	Flowable adhesive compliant with FDA, USDA and NSF. UL listed. MIL-A-46106B.	High temperature, flowable adhesive compliant with FDA, USDA and NSF. UL listed. MIL-A-46106B.	High strength, paste adhesive.	High temperature, high strength, paste adhesive.	Fluorosilicone, paste adhesive. Excellent resistance to fuel, oil, moisture, UV, ozone and chemicals.	Oil-resistant, heavy-bodied, paste adhesive.	Paste adhesive with FDA, USDA, and NSF compliance. UL94 HB recognition.	High temperature, paste adhesive with FDA, USDA, and NSF compliance. UL94 HB recognition.
<b>Typical Applications (include but not limited to)</b>	Electrical insulation; Formed-in-place gaskets; Assembly applications; Sealing and bonding.	Sealing heating elements; Gasketing; Electrical insulation; Sealing and bonding.	Electrical insulation; Thin section potting; Self leveling protective coatings; Assembly applications.	Thin section potting; Self leveling protective coatings; Electrical insulation.	High voltage wire and cables; Valve sealants; Turbines; Fluid metering devices; Gaskets and sealing devices.	High voltage wire and cables; Valve sealants; Turbines; Fluid metering devices; Gaskets and sealing devices.	Formed-in-place gasketing; Sealing seams; Fuel handling systems; Sealing and bonding; Valve manufacturers.	Formed-in-place gasketing; Sealing and bonding.	Sealing and bonding.	Sealing and bonding.
<b>Key Substrate Adhesion</b>	Primerless adhesion to many metals, plastics and glass.	Primerless adhesion to many metals, plastics and glass.	Primerless adhesion to many metals, plastics and glass.	Primerless adhesion to many metals, plastics and glass.	Primerless adhesion to many metals, plastics and glass.	Primerless adhesion to many metals, plastics and glass.	Primerless adhesion to many metals, plastics and glass.	Primerless adhesion to many metals, plastics and glass.	Primerless adhesion to many metals, plastics and glass.	Primerless adhesion to many metals, plastics and glass.
<b>Color (Final Product)</b>	RTV102: White RTV103: Black RTV108: Translucent RTV109: Aluminum	Red	RTV112: White RTV118: Translucent	Red	Gray	Red	Red	Black	IS802: White IS803: Black IS808: Translucent IS800.09: Aluminum	Red
<b>Viscosity (cps)/ Application Rate (g/min)</b>	400 g/min	400 g/min	RTV112: 25,000 cps RTV118: 25,000 cps	25,000 cps	180 g/min	180 g/min	92 g/min	375 g/min	425 g/min	550 g/min
<b>Useful Temperature Range</b>	-60 to 205°C (-75 to 400°F)	-60 to 260°C (-75 to 500°F)	-60 to 205°C (-75 to 400°F)	-60 to 260°C (-75 to 500°F)	-60 to 205°C (-75 to 400°F)	-60 to 260°C (-75 to 500°F)	-60 to 205°C (-75 to 400°F)	-60 to 205°C (-75 to 400°F)	-60 to 205°C (-75 to 400°F)	-60 to 260°C (-75 to 500°F)
<b>Specific Gravity</b>	1.06	1.08	1.05	1.10	1.10	1.11	1.45	1.06	1.04	1.05
<b>Hardness, Shore A Durometer</b>	30	30	25	20	28	28	39	30	23	22
<b>Tensile Strength (psi)</b>	400	375	325	350	975	1025	485	450	300	250
<b>Elongation (%)</b>	450	400	325	350	825	825	200	500	450	425
<b>Dielectric Strength (75 mils, V/mil)</b>	500	500	400	400	525	500	-	-	500	500
<b>Dielectric Constant (60 Hz)</b>	2.80	2.80	2.80	2.80	2.90	2.60	-	-	2.90	2.90
<b>Linear Shrinkage (%)</b>	1.0	1.0	1.0	1.0	1.0	1.0	-	-	-	-
<b>Processing: Tack Free Time</b>	20 minutes	20 minutes	20 minutes	30 minutes	45 minutes	45 minutes	20 minutes	25 minutes	30 minutes	30 minutes
<b>Cure Time @ 25°C (77°F)<sup>++</sup></b>	24 hours	24 hours	24 hours	24 hours	24 hours	24 hours	24 hours	24 hours	24 hours	24 hours

Note: Additional information may be available on the technical datasheet. This chart contains typical property values and actual values or results may vary.

+ These sealants are not for use in delicate electrical and electronic applications in which corrosion of copper, brass and other sensitive metals is undesirable.

++ Cure times are typical values which may be affected by bead size, temperature, relative humidity, and the equipment used. Full property development with standard condensation cure products may take 3 to 7+ days (at 25°C and 50% RH).

(1) IS802 does not currently meet FDA regulation 21CFR177.2600 "Rubber Articles Intended for Repeated Use."

One-Part Condensation Cure: Neutral (Alkoxy and Modified Alkoxy) Cure Chemistry

HIGH PERFORMANCE, NON-CORROSIVE <sup>(1)</sup>												
	FAST CURE		UL94 V-0				FAST CURE					LOW VOLATILE
	ECC3050S	RTV5220 Series	RTV167	RTV162	RTV133	RTV160	RTV5240 Series	TSE392	TSE3991-C	TSE399	TSE397	RTV142
<b>Features</b>	Fast curing, low viscosity conformal coating with a UV tracer, low VOC, excellent adhesion and room/low temperature cure capability. UL recognized under File QMJU2-E135148. <sup>(2)</sup>	Low modulus, paste adhesive. UL94 HB recognition.	Highest strength, paste adhesive. UL94 HB recognition. MIL-A-46146B.	High strength, paste adhesive. UL94 HB recognition. MIL-A-46146B.	High temperature, paste adhesive. UL94 HB recognition.	Flowable adhesive. UL94 HB recognition.	Hydrolytically stable, paste adhesive with fast green strength build. UL94 HB recognition.	Paste adhesive. UL94 HB recognition.	Flowable adhesive.	Flowable adhesive.	Semi-flowable adhesive. UL94 HB recognition.	Low volatile, paste adhesive.
<b>Typical Applications (include but not limited to)</b>	Printed circuit board assemblies with temperature limited components; Electronic assemblies; High volume production conformal coating applications.	Assembly applications; Masonry applications; Weatherproofing seals; Applications that require a long tooling time; Sealing and bonding.	Mechanical/Electrical bonding and insulating applications; Electronic applications.	Bond capacitors, resistors and integrated circuits to PCB's; Seal exposed wires, faying surfaces, and connectors; Electronic parts assemblies.	Firewalls; Flame retardant coating; Switching devices; Motors; High voltage transformers.	Thin-section PCB coating; Insulating, encapsulating, and coating in thin sections; Electronic and integrated circuits; Semiconductors.	Assembly applications; Headlamps; Weatherproofing seals; Sealing and bonding.	Electronic sealing and coating.	Moisture proof sealing, potting, and coating of electric and electronic parts and LED displays.	Insulating coating and potting for transistor and high-voltage parts; Waterproof coating for electrical, electronic and communication equipment; Electronic and integrated circuits and semiconductors, copper connections on electric parts assemblies.	Electronic sealing and coating; Waterproof sealant for electrical, electronic and communication equipment.	Electronic adhesive; Electronic gasketing; Sealing and bonding.
<b>Key Substrate Adhesion</b>	Primerless adhesion to many metals, plastics and glass.	Primerless adhesion to many metals, plastics, masonry, wood, glass and ceramics.	Primerless adhesion to many metals, plastics, masonry, wood, glass and ceramics.	Primerless adhesion to many metals, plastics, masonry, wood, glass and ceramics.	Primerless adhesion to many metals, plastics, masonry, wood, glass and ceramics.	Primerless adhesion to many metals, plastics, masonry, wood, glass and ceramics.	Primerless adhesion to many metals, plastics, masonry, wood, glass and ceramics.	Primerless adhesion to many metals, plastics, masonry, wood, glass and ceramics.	Primerless adhesion to many metals, plastics, masonry, wood, glass and ceramics.	Primerless adhesion to many metals, plastics, masonry, wood, glass and ceramics.	Primerless adhesion to many metals, plastics, masonry, wood, glass and ceramics.	Primerless adhesion to many metals, plastics, masonry, wood, glass and ceramics.
<b>Cure Chemistry</b>	Alkoxy	Alkoxy	Alkoxy	Alkoxy	Alkoxy	Alkoxy	Alkoxy	Alkoxy	Alkoxy	Alkoxy	Alkoxy	Alkoxy
<b>Color (Final Product)</b>	Transparent	RTV5222: White RTV5223: Black RTV5229: Gray	Gray	White	Black	White	RTV5242: White RTV5243: Black RTV5249: Gray	TSE392-C: Translucent TSE392-W: White	Translucent	TSE399-B: Black TSE399-C: Translucent TSE399-W: White	TSE397-B: Black TSE397-C: Translucent TSE397-W: White	White
<b>Viscosity (cps)/ Application Rate (g/min)</b>	550 cps	185 g/min	200 g/min	475 g/min	700 g/min	35,000 cps	250 g/min	-	1,500 cps	2,500 cps	50,000 cps	725 g/min
<b>Useful Temperature Range</b>	-60 to 205°C (-75 to 400°F)	-60 to 205°C (-75 to 400°F)	-60 to 205°C (-75 to 400°F)	-60 to 205°C (-75 to 400°F)	-60 to 205°C (-75 to 400°F)	-60 to 205°C (-75 to 400°F)	-60 to 205°C (-75 to 400°F)	-55 to 200°C (-67 to 392°F)	-55 to 200°C (-67 to 392°F)	-55 to 200°C (-67 to 392°F)	-55 to 200°C (-67 to 392°F)	-60 to 205°C (-75 to 400°F)
<b>Specific Gravity</b>	0.98	1.40	1.12	1.09	1.23	1.04	1.50	1.04	1.03	1.04	1.04	1.09
<b>Hardness, Shore A Durometer</b>	22	26	37	35	45	25	40	30	19	25	20	34
<b>Tensile Strength (psi)</b>	-	370	800	550	650	275	320	228	105	190	175	550
<b>Elongation (%)</b>	-	750	600	400	250	230	425	400	150	140	360	400
<b>Dielectric Strength (75 mils, V/mil)</b>	508	420	500	450	500	500	500	560	450	500	560	500
<b>Dielectric Constant (60 Hz)</b>	2.60	3.90	2.90	2.80	2.80 @ 100 Hz	2.80	2.80	2.90	2.90	2.90	2.90	2.80
<b>Volume Resistivity (ohm-cm)</b>	1 x 10 <sup>15</sup>	5.4 x 10 <sup>15</sup>	3.0 x 10 <sup>15</sup>	3.0 x 10 <sup>15</sup>	3.0 x 10 <sup>15</sup>	4.0 x 10 <sup>14</sup>	3.0 x 10 <sup>15</sup>	2.0 x 10 <sup>15</sup>	2.0 x 10 <sup>15</sup>	2.0 x 10 <sup>15</sup>	2.0 x 10 <sup>15</sup>	4.5 x 10 <sup>15</sup>
<b>Processing: Tack Free Time</b>	-	3 hours	4 hours	4 hours	1 hour	4 hours	5 minutes	5 minutes	10 minutes	10 minutes	10 minutes	4 hours
<b>Cure Time+ @ 25°C (77°F)</b>	30 minutes (23°C)	24 hours	24 hours	24 hours	24 hours	24 hours	24 hours	24 hours	24 hours	24 hours	24 hours	24 hours
<b>60°C</b>	< 5 minutes	-	-	-	-	-	-	-	-	-	-	-

Note: Additional information may be available on the technical datasheet. This chart contains typical property values and actual values or results may vary.

<sup>(1)</sup> Non-corrosive to most sensitive metals.

<sup>(2)</sup> UL recognition as a permanent coating.

+ Cure times are typical values which may be affected by bead size, temperature, relative humidity, and the equipment used. Full property development with standard condensation cure products may take 3 to 7+ days (at 25°C and 50% RH).

One-Part Condensation Cure: Neutral (Alkoxy and Modified Alkoxy) Cure Chemistry

	HIGH PERFORMANCE					GENERAL PURPOSE
	RTV1673LV	RTV6700 Series++	RTF5308	RTV5810 Series++	RTV120 Series++	IS902
<b>Features</b>	Low volatile, paste adhesive. Non-corrosive to aluminum and steel.	Paste adhesive. UL94 HB recognition.	Fast curing, paste adhesive. Capable of being mechanically foamed.	Fast curing, paste adhesive designed to provide quick initial adhesion build. UL94 HB recognition.	Paste adhesive. UL94 HB recognition. MIL-A-46146B.	Paintable adhesive offering superb weatherability and long-term performance; Linear shrinkage of less than 2%.
<b>Typical Applications (include but not limited to)</b>	Gasketing; Under hood applications.	May be suitable for applications in confined spaces; Applications requiring long work life for tooling of finished assemblies.	Formed-in-place gaskets; Vertical and Horizontal applications; Hot/Cold thermal cycles; Expandable Silicone Foam per GM2224M2D2CF1, Type II.	Assembly applications requiring high productivity; Sealed assemblies; May be suitable for applications in confined spaces.	Sealing vertical joints; Electrical insulation of wires and terminals; Formed-in-place gasketing.	Interior and exterior applications; Sealing and bonding; Weatherproofing seals; Adhering auto and appliance trim.
<b>Key Substrate Adhesion</b>	Primerless adhesion to many metals, plastics, masonry, wood, glass and ceramics. Not recommended for use on polycarbonates and acrylics.	Primerless adhesion to many metals, plastics, masonry, wood, glass and ceramics. Not recommended for use on polycarbonates and acrylics.	Primerless adhesion to many metals, plastics, masonry, wood, glass and ceramics. Not recommended for use on polycarbonates and acrylics.	Primerless adhesion to many metals, plastics, masonry, wood, glass and ceramics. Not recommended for use on polycarbonates and acrylics.	Primerless adhesion to many metals, plastics, masonry, wood, glass and ceramics. Not recommended for use on polycarbonates and acrylics.	Primerless adhesion to many metals, plastics, masonry, wood, glass and ceramics.
<b>Cure Chemistry</b>	Modified Alkoxy	Modified Alkoxy	Modified Alkoxy	Modified Alkoxy	Modified Alkoxy	Modified Alkoxy
<b>Color (Final Product)</b>	Black	RTV6702: White RTV6703: Black RTV6708: Translucent	Translucent	RTV5812: White RTV5813: Black RTV5818: Translucent	RTV122: White RTV123: Black RTV128: Translucent	White
<b>Viscosity (cps)/ Application Rate (g/min)</b>	750 seconds	250 g/min	290 g/min	480 g/min	600 g/min	-
<b>Useful Temperature Range</b>	-60 to 205°C (-75 to 400°F)	-60 to 205°C (-75 to 400°F)	-60 to 205°C (-75 to 400°F)	-60 to 205°C (-75 to 400°F)	-60 to 205°C (-75 to 400°F)	-60 to 205°C (-75 to 400°F)
<b>Specific Gravity</b>	1.06	1.04	1.04	1.04	1.04	-
<b>Hardness, Shore A Durometer</b>	28	18	22	21	30	33
<b>Tensile Strength (psi)</b>	360	225	305	275	250	230
<b>Elongation (%)</b>	560	450	485	500	350	350
<b>Dielectric Strength (75 mils, V/mil)</b>	500	409	-	425	500	-
<b>Dielectric Constant (60 Hz)</b>	2.60	2.9 @ 100 Hz	-	2.8 @ 100 Hz	2.80	-
<b>Volume Resistivity (ohm-cm)</b>	2.0 x 10 <sup>15</sup>	2.0 x 10 <sup>15</sup>	-	2.0 x 10 <sup>15</sup>	4.0 x 10 <sup>15</sup>	-
<b>Processing:</b>						
<b>Tack Free Time</b>	15 minutes	25 minutes	18 minutes	15 minutes	20 minutes	< 2 hours
<b>Cure Time @ 25°C (77°F)+</b>	24 hours	24 hours	12 - 24 hours	12 to 24 hours	24 hours	5 to 7 days

Note: Additional information may be available on the technical datasheet. This chart contains typical property values and actual values or results may vary.

+ Cure times are typical values which may be affected by bead size, temperature, relative humidity, and the equipment used. Full property development with standard condensation cure products may take 3 to 7+ days (at 25°C and 50% RH).

++ When allowed to cure in enclosed conditions, these sealants may discolor sensitive metals they are in direct contact with.

## One-Part Condensation Cure: Oxime Cure Chemistry<sup>(1)</sup>

The oxime series generally offer cost-effective solutions, fast tack free times and primerless adhesion to a variety of substrates. Typical applications include, but are not limited to, general bonding and sealing, electrical applications and automotive applications.

	GENERAL PURPOSE	HIGH TEMPERATURE	UL94 V-1	GENERAL PURPOSE	
	TSE382	TSE3826	TSE3843-W	TSE387	TSE389
<b>Features</b>	General purpose, paste adhesive, UL746 TI (Electrical 150°C; Mechanical 140°C). UL94 HB recognition.	High temperature performing, paste adhesive; UL746 temperature index of 200°C.	Flame retardant, semi-flowable paste adhesive. UL94 V-1 recognition.	Flowable adhesive.	Flowable adhesive; UL94 HB recognition.
<b>Typical Applications (include but not limited to)</b>	Sealing and bonding for electrical and telecommunications equipment, meters, windshields, automotive engine parts.	Sealing and encapsulating of heating elements in appliances; Electrical insulation; General sealing and bonding.	Sealing of electrical, industrial and high voltage applications where flame retardancy is required.	Industrial sealing and coating; Electrical insulation; Thin section potting of electrical components; General sealing and bonding.	Industrial sealing and coating; Electrical insulation; Thin section potting of electrical components.
<b>Cure Chemistry</b>	Oxime	Oxime	Oxime	Oxime	Oxime
<b>Color (Final Product)</b>	TSE382-W: White TSE382-B: Black TSE382-C: Clear	Reddish Brown	White	TSE387-W: White TSE387-B: Black TSE387-C: Clear	TSE389-W: White TSE389-B: Black TSE389-C: Clear
<b>Viscosity (cps)</b>	–	–	500,000	60,000	5,600
<b>Useful Temperature Range</b>	-55 to 200°C (-67 to 392°F)	-55 to 250°C (-67 to 482°F)	-55 to 200°C (-67 to 392°F)	-55 to 200°C (-67 to 392°F)	-55 to 200°C (-67 to 392°F)
<b>Specific Gravity</b>	1.04	1.04	1.57	1.04	–
<b>Hardness, Shore A Durometer</b>	28	29	60	25	30
<b>Tensile Strength (psi)</b>	275	290	260	260	290
<b>Elongation (%)</b>	380	400	130	300	200
<b>Dielectric Strength (kV/mm)</b>	23	23	–	20	20
<b>Volume Resistivity (ohm-cm)</b>	1.0 x 10 <sup>15</sup> ohm-cm	1.0 x 10 <sup>15</sup> ohm-cm	1.0 x 10 <sup>7</sup> Mohm-m	1.0 x 10 <sup>15</sup> ohm-cm	1.0 x 10 <sup>15</sup> ohm-cm
<b>Thermal Conductivity (W/mK)</b>	0.18	0.18	0.67	0.18	0.18
<b>Processing:</b>					
<b>Tack Free Time (23°C)</b>	10 minutes	10 minutes	60 minutes	90 minutes	30 minutes
<b>Cure Time @ 25°C (77°F)<sup>+</sup></b>	24 hours	24 hours	24 hours	24 hours	24 hours

Note: Additional information may be available on the technical datasheet. This chart contains typical property values and actual values or results may vary.

<sup>(1)</sup> Non-corrosive to most sensitive metals but may cause corrosion to copper and copper alloys; May cause some discoloration to certain sensitive metals such as copper and brass.

<sup>+</sup> Cure times are typical values which may be affected by bead size, temperature, relative humidity and the equipment used. Full property development with standard condensation cure products may take 3 to 7+ days (at 25°C and 50% RH).



Two-Part Condensation (Alkoxy) Cure

	HIGH PERFORMANCE												
	FAST CURE			EXTREME HIGH TEMPERATURE PERFORMANCE				HIGH AND LOW TEMPERATURE PERFORMANCE			EXTREME LOW TEMPERATURE PERFORMANCE		
	SnapSil® RTV230 Series	RTV200 Series	TSE3664	RTV31	RTV60	RTV8262	RTV88 RTV88HB	RTV560	RTV566	RTV567	RTV511	RTV577	
<b>Features</b>	Extremely fast room temperature cure and green strength build. May offer high levels of productivity. Extended room temperature storage. UL94 HB recognition.	Fast room temperature cure, high strength adhesive offering flexible mix ratios and tack free times.	Fast cure, low viscosity adhesive with deep section cure capability. UL94 V-0 recognition.	Flowable sealant with variable work times and cure rates available through catalyst options. Excellent release capabilities.	Flowable sealant with variable work times and cure rates available through catalyst options. Excellent release capabilities.	High temperature, flowable sealant. MIL-PRF-23586F (non-corrosive to copper).	Spreadable paste sealant with variable work times and cure rates available through catalyst options. Excellent release capabilities.	Flowable sealant with low and high temperature performance capability. Variable work times and cure times available through catalyst options. Excellent release capabilities.	Low volatile, low outgassing sealant with low and high temperature performance capability. Excellent release capabilities.	Low volatile, low outgassing sealant. Excellent release properties.	Flowable sealant with variable work times and cure times available through catalyst options. Excellent release capabilities.	Paste sealant with variable work times and cure times available through catalyst options. Excellent release capabilities.	
<b>Typical Applications (include but not limited to)</b>	Applications that require greater productivity; Industrial assembly applications; Appliances; Automotive components.	Assembly applications; Automotive components.	Solar cells/modules; Automotive electronics; Electronic devices; Home appliances; Moisture proof sealing of meters; Moisture proof coating of electronic circuit boards; Potting of electric and communication parts.	Fabrication of rubber parts; Potting and encapsulating (electric motors and transformers, surge protectors, industrial filters); Release applications such as rubber rollers; Thermal insulation; Mechanical protection.	Potting, encapsulating, cushioning and coating.	Potting of electronic circuit modules, electrical connectors and coils.	Fabrication of rubber parts; Potting and encapsulating electric motors and transformers; Casting molds for low-melting point metals; Release applications such as rubber rollers; Thermal insulation.	Cast-in-place heat shielding; Thermal insulation; Potting and encapsulating of electrical assemblies.	Low outgassing applications; Cast-in-place heat shielding; Thermal insulation; Potting and encapsulating of electrical assemblies.	Applications that require a low outgassing product.	Cast-in-place heat shielding; Thermal insulation; Potting and encapsulating of electrical assemblies.	Cast-in-place heat shielding; Thermal insulation; Potting and encapsulating of electrical assemblies.	
<b>Key Substrate Adhesion</b>	Offers primerless adhesion to many metals, plastics and glass.	Offers primerless adhesion to many metals, plastics and glass.	Aluminum, Stainless Steel, Plastics (Epoxy resin, polyester, phenolic resin), Glass.	May require a primer for bonding.	May require a primer for bonding.	May require a primer for bonding.	May require a primer for bonding.	May require a primer for bonding.	May require a primer for bonding.	May require a primer for bonding.	May require a primer for bonding.	May require a primer for bonding.	
<b>Cure Chemistry</b>	Alkoxy	Alkoxy	Alkoxy	Alkoxy	Alkoxy	Alkoxy	Alkoxy	Alkoxy	Alkoxy	Alkoxy	Alkoxy	Alkoxy	
<b>Mix Ratio (base to curing agent by wt %)</b>	RTV230A/230B, RTV239A/230B: 12:1 RTV233A/230B: 11:1	RTV210B & RTV213B: 12.5:1 by weight RTV224B: 10:1 by weight	100:7.5	100:0.5	100:0.5	100:5	100:0.5	100:0.5	100:0.1	100:0.1	100:0.5	100:0.5	
<b>Standard Catalyst</b>	RTV230B	-	TSE3664B	DBT	DBT	RTV9858	RTV88: DBT RTV88HB: RTV9950	DBT	RTV566B	RTV567B	DBT	DBT	
<b>Catalyst Options Available<sup>+</sup></b>	None	RTV210B, RTV213B, RTV224B	None	Yes	Yes	None	RTV88: Yes	Yes	None	None	Yes	Yes	
<b>Color (Final Product)</b>	RTV230A/230B: White RTV233A/230B: Black RTV239A/230B: Gray	Gray to Black	Gray	Red	Red	Red	Red	Red	Red	Translucent	White	White	
<b>Viscosity (cps)</b>	RTV230A/233A/239A: 700,000; RTV230B: 95,000	Paste	3,000	25,000	40,000	47,000	880,000	30,000	42,700	3,900	16,000	700,000	
<b>Useful Temperature Range</b>	-50 to 205°C (-58 to 400°F); RTV233A/230B: -50°C to 250°C (-58°F to 482°F)	-50 to 205°C (-58 to 400°F)	-54 to 205°C (-65 to 400°F)	-54 to 260°C (-65 to 500°F)	-54 to 260°C (-65 to 500°F)	-54 to 260°C (-65 to 500°F)	-54 to 260°C (-65 to 500°F)	-115 to 260°C (-175 to 500°F)	-115 to 260°C (-175 to 500°F)	-115 to 205°C (-175 to 400°F)	-115 to 205°C (-175 to 400°F)	-115 to 205°C (-175 to 400°F)	
<b>Specific Gravity</b>	RTV230A/230B, RTV239A/230B: 1.39 RTV233A/230B: 1.28	1.35	1.41	1.42	1.48	1.47	1.47	1.42	1.49	1.00	1.21	1.35	
<b>Hardness, Shore A Durometer</b>	36	33 - 36	60	54	57	52	58	55	61	20	42	48	
<b>Tensile Strength (psi)</b>	250	250	435	870	990	580	830	690	800	-	380	440	
<b>Elongation (%)</b>	250	250	70	170	120	150	120	120	120	-	170	150	
<b>Tear Strength (Die B, lb/in)</b>	-	-	-	29	40	43	42	31	-	-	21	38	
<b>Thermal Conductivity (W/mK)</b>	-	-	0.42	0.34	0.34	0.34	0.34	0.31	-	0.29	0.26	0.31	
<b>Coefficient of Thermal Expansion (Linear CTE, cm/cm °C (in/in °F))</b>	-	-	-	20 x 10 <sup>-5</sup> (11 x 10 <sup>-5</sup> )	20 x 10 <sup>-5</sup> (11 x 10 <sup>-5</sup> )	20 x 10 <sup>-5</sup> (11 x 10 <sup>-5</sup> )	20 x 10 <sup>-5</sup> (11 x 10 <sup>-5</sup> )	20 x 10 <sup>-5</sup> (11 x 10 <sup>-5</sup> )	-	25 x 10 <sup>-5</sup> (14 x 10 <sup>-5</sup> )	22 x 10 <sup>-5</sup> (12 x 10 <sup>-5</sup> )	20 x 10 <sup>-5</sup> (11 x 10 <sup>-5</sup> )	
<b>Dielectric Strength (75 mils, V/mil)</b>	410	-	660	4.3	450	470	440	540	-	515	520	470	
<b>Dielectric Constant (1 kHz)</b>	375 (60Hz)	-	3.1 (60Hz)	4.4	4.0	3.9	4.3	3.9	-	3.3	3.6	3.9	
<b>Dissipation Factor (1 kHz)</b>	0.13 (60Hz)	-	0.01 (60Hz)	0.03	0.02	0.017	0.03	0.02	-	0.006	0.005	0.02	
<b>Volume Resistivity (ohm-cm)</b>	9.13 x 10 <sup>13</sup> µ-cm	-	5 x 10 <sup>15</sup>	1.6 x 10 <sup>14</sup>	4.4 x 10 <sup>14</sup>	4.4 x 10 <sup>14</sup>	2.8 x 10 <sup>14</sup>	2 x 10 <sup>14</sup>	-	1.1 x 10 <sup>15</sup>	2 x 10 <sup>14</sup>	5.6 x 10 <sup>14</sup>	
<b>Linear Shrinkage (%)</b>	-	-	-	0.6	0.6	0.6	0.6	1	-	0.6	1.3	0.65	
<b>Processing: Work (Pot) Life</b>	5-10 minutes	10-30 minutes	10 minutes	2 hours	2 hours	2 hours	0.75 hours	2.25 hours	1.5 hours	9 hours	1.5 hours	2 hours	
<b>Cure Time @ 25°C (77°F)<sup>++</sup></b>	30 minutes <sup>(1)</sup>	24 hours	24 hours	24 hours	24 hours	24 hours	24 hours	24 hours	24 hours	24 hours	24 hours	24 hours	

Note: Additional information may be available on the technical datasheet. This chart contains typical property values and actual values or results may vary.  
<sup>(1)</sup> Full property development can take up to 72 hours.

<sup>+</sup> For the products that have catalyst options, please refer to page 19 for a detailed listing of choices.  
<sup>++</sup> Cure times are typical values which may be affected by bead size, temperature, relative humidity and equipment used.  
Full property development with standard condensation cure products may take 3 to 7+ days (at 25°C and 50% RH).

## Two-Part Condensation (Alkoxy) Cure

	GENERAL PURPOSE					
	RTV12	RTV8111	RTV8112	RTV11	RTV21	RTV41
<b>Features</b>	Low viscosity adhesive offering deep section cure capability, easy repair capability, can apply heat up to 85°C to attain a faster cure.	Flowable sealant. MIL-PRF-23586F (non-corrosive to copper).	Flowable sealant. MIL-PRF-23586F (non-corrosive to copper).	Sealant with variable work time and cure time available through catalyst options. Excellent release properties.	Sealant with variable work time and cure time available through catalyst options. Excellent release properties.	Sealant with variable work time and cure time available through catalyst options. Excellent release properties.
<b>Typical Applications (include but not limited to)</b>	Electrical and electronic potting; High and low voltage electrical assemblies.	Potting of electronic circuit modules, electrical connectors and coils.	Potting of electronic circuit modules, electrical connectors and coils.	Cast-in-place gaskets and molds; Medical molds/instruments; High voltage power supply potting; Electrical potting.	Cast-in-place gaskets and molds; Medical molds/instruments; High voltage power supply potting; Electrical potting.	Cast-in-place gaskets and molds; Medical molds/instruments; High voltage power supply potting; Electrical potting.
<b>Key Substrate Adhesion</b>	Primerless adhesion to many metals, plastics and glass.	May require a primer for bonding.	May require a primer for bonding.	May require a primer for bonding.	May require a primer for bonding.	May require a primer for bonding.
<b>Cure Chemistry</b>	Alkoxy	Alkoxy	Alkoxy	Alkoxy	Alkoxy	Alkoxy
<b>Mix Ratio (base to curing agent by weight)</b>	20 : 1	100 : 2	100 : 5	100 : 0.5	100 : 0.5	100 : 0.5
<b>Standard Catalyst</b>	RTV12C	RTV9891	RTV9858	DBT	DBT	DBT
<b>Catalyst Options Available<sup>+</sup></b>	None	None	None	Yes	Yes	Yes
<b>Color (Final Product)</b>	Clear	White	White	White	Pink	White
<b>Viscosity (cps)</b>	1,300	9,900	11,000	11,000	26,000	39,000
<b>Useful Temperature Range</b>	-54 to 205°C (-65 to 400°F)	-54 to 205°C (-65 to 400°F)	-54 to 205°C (-65 to 400°F)	-54 to 205°C (-65 to 400°F)	-54 to 205°C (-65 to 400°F)	-54 to 205°C (-65 to 400°F)
<b>Specific Gravity</b>	1.00	1.18	1.19	1.19	1.32	1.31
<b>Hardness, Shore A Durometer</b>	18	45	42	41	45	47
<b>Tensile Strength (psi)</b>	–	350	300	510	310	520
<b>Elongation (%)</b>	200	160	160	190	210	180
<b>Tear Strength (Die B, lb/in)</b>	–	24	27	20	40	29
<b>Thermal Conductivity (W/mK)</b>	0.17	0.29	0.29	0.29	0.31	0.31
<b>Coefficient of Thermal Expansion (Linear CTE, cm/cm °C (in/in °F))</b>	29 x 10 <sup>-5</sup> (16 x 10 <sup>-5</sup> )	25 x 10 <sup>-5</sup> (14 x 10 <sup>-5</sup> )	25 x 10 <sup>-5</sup> (14 x 10 <sup>-5</sup> )	25 x 10 <sup>-5</sup> (14 x 10 <sup>-5</sup> )	20 x 10 <sup>-5</sup> (11 x 10 <sup>-5</sup> )	20 x 10 <sup>-5</sup> (11 x 10 <sup>-5</sup> )
<b>Dielectric Strength (75 mils, V/mil)</b>	400	500	475	515	420	520
<b>Dielectric Constant (1 kHz)</b>	3.0	3.3	4.0	3.3	3.8	3.7
<b>Dissipation Factor (1 kHz)</b>	0.001	0.0055	0.007	0.006	0.02	0.007
<b>Volume Resistivity (ohm-cm)</b>	1 x 10 <sup>13</sup>	1.0 x 10 <sup>15</sup>	2.7 x 10 <sup>15</sup>	1.1 x 10 <sup>15</sup>	2.6 x 10 <sup>14</sup>	1.6 x 10 <sup>14</sup>
<b>Linear Shrinkage (%)</b>	2.0	1.0	1.0	0.6	0.6	0.6
<b>Processing:</b>						
<b>Work (Pot) Life</b>	1.6 hours	0.5 hours	2 hours	1.5 hours	1 hour	1 hour
<b>Cure Time @ 25°C (77°F)<sup>++</sup></b>	24 hours	24 hours	24 hours	24 hours	24 hours	24 hours

Note: Additional information may be available on the technical datasheet. This chart contains typical property values and actual values or results may vary.

<sup>+</sup> For the RTVs that have catalyst options, please refer to page 19 for a detailed listing of choices.

<sup>++</sup> Cure times are typical values which may be affected by bead size, temperature, relative humidity, and equipment used. Full property development with standard condensation cure products may take 3 to 7+ days (at 25°C and 50% RH).

## Two-Part Condensation Cure: Catalyst Options

Curing Agent	Features	Curing Agent Concentration (wt%)
<b>DBT</b>	Standard curing agent. Small volume of curing agent to add. Best for small volume applications.	<b>0.1% to 0.5% (suggested 200:1)</b>
Cure Speed	Moderate	
Color	Clear to Amber	
Consistency	Easily Pourable	
Work Life (hrs)	1 to 5	
Cure Time (hrs)	24 to 48	
<b>RTV9811</b>	May be used with automatic mixing equipment, large volume applications. Good deep section cure. Less affected by atmospheric conditions.	<b>5% to 10% (suggested 10:1)</b>
Cure Speed	Moderate	
Color	Light Beige	
Specific Gravity	1.50	
Consistency	Paste	
Work Life (hrs)	0.5 to 1.5	
Cure Time (hrs)	12 to 24	
<b>RTV9910</b>	Paste version of 0.1% DBT. May be used with automatic mixing equipment, large volume applications.	<b>5% to 10% (suggested 10:1)</b>
Cure Speed	Slow	
Color	Tan	
Specific Gravity	1.81	
Consistency	Paste	
Work Life (hrs)	3 to 6	
Cure Time (hrs)	24 to 48	
<b>RTV9950</b>	Paste version of 0.5% DBT. May be used with automatic mixing equipment, large volume applications.	<b>5% to 10% (suggested 10:1)</b>
Cure Speed	Moderate	
Color	White	
Specific Gravity	1.75	
Consistency	Paste	
Work Life (hrs)	1 to 3	
Cure Time (hrs)	16 to 24	
<b>RTV9858</b>	Paste version of DBT.	<b>5% to 7%</b>
Cure Speed	Moderate	
Color	Light Beige	
Consistency	Paste	
Work Life (hrs)	1 to 3	
Cure Time (hrs)	18 to 24	
<b>STO</b>	Small volume of curing agent to add. Best for short production cycles, rapid production of cured parts. Best choice for reversion resistance. Less affected by atmospheric conditions.	<b>0.2% to 0.5% (suggested 200:1)</b>
Cure Speed	Fast	
Color	Clear to Amber	
Consistency	Easily Pourable	
Work Life (hrs)	0.1 to 0.5	
Cure Time (hrs)	4 to 12	
<b>RTV9891</b>	Paste version of STO.	<b>2% to 4%</b>
Cure Speed	Fast	
Color	Blue	
Specific Gravity	1.78	
Consistency	Paste	
Work Life (hrs)	0.1 to 0.5	
Cure Time (hrs)	4 to 12	

Notes: Typical property values are recorded at standard testing conditions of 25°C (77°F) and 50% relative humidity. Actual data or results may vary.

Catalyst options are used in place of the standard DBT catalyst provided.

One-Part Addition Cure<sup>(1)</sup>

	FAST CURE		TSE3251	HIGH TEMPERATURE	
	ECC4865	RTV6424		TSE326	TSE322
<b>Features</b>	Low viscosity, conformal coating with a UV tracer, fast thermal cure and outstanding long-term viscosity stability. UL recognized under File QMJU2-E135148.	Fast heat curing, paste adhesive with low linear shrinkage and excellent dielectric properties.	Flowable, heat curing adhesive.	High temperature, flowable, heat curing adhesive. UL94 HB recognition.	Semi-flowable or flowable adhesive with low linear shrinkage and excellent dielectric properties. UL94 HB recognition.
<b>Typical Applications (include but not limited to)</b>	Printed circuit boards and other electronic assemblies; Applications requiring moisture and environmental protection.	Thermal barrier for automotive parts.	Coating of hybrid IC's and printed circuit boards; Dip coating and and encapsulating; Sealing and bonding.	High heat assembly, gasketing and coating applications; Electronic applications; Silk screen printing.	Electronics sealing, bonding, and coating; Thermal barrier for automotive parts; Fabric seam seal.
<b>Key Substrate Adhesion</b>	Primerless adhesion to many metals, plastics and glass.	Primerless adhesion to many metals, plastics and glass.	Primerless adhesion to many metals, plastics and glass.	Primerless adhesion to many metals, plastics and glass.	Primerless adhesion to many metals, plastics and glass.
<b>Color (Final Product)</b>	Transparent	White	White	Red	TSE322, TSE322S: Light blue
<b>Viscosity (cps)</b>	240	800,000	8,500	28,000	TSE322: 110,000 TSE322S: 70,000
<b>Useful Temperature Range</b>	-40 to 200°C (-40 to 328°F)	-60 to 205°C (-75 to 400°F)	-60 to 205°C (-75 to 400°F)	-54 to 260°C (-65 to 500°F)	-60 to 205°C (-75 to 400°F)
<b>Specific Gravity</b>	0.98	1.17	1.02	1.45	1.28
<b>Hardness, Shore A Durometer</b>	35	30	16	43	45
<b>Tensile Strength, (psi)</b>	-	675	102	498	425
<b>Elongation (%)</b>	-	550	200	170	200
<b>Dielectric Strength (75 mils, V/mil)</b>	500	500	500	558	500
<b>Dielectric Constant (60 Hz)</b>	2.4	2.9	2.8	3.3	3.1
<b>Volume Resistivity (ohm-cm)</b>	5 x 10 <sup>14</sup>	1 x 10 <sup>13</sup>	2 x 10 <sup>15</sup>	2.0 x 10 <sup>15</sup>	1.0 x 10 <sup>15</sup>
<b>Processing:</b>					
<b>Cure Time @</b>					
<b>100°C</b>	Cure time of 10 minutes @ 125°C. Cure temperature range 105 to 175°C.	-	4 hours	2 hours	3 hours
<b>125°C</b>		45 minutes	2 hours	1.5 hours	1.5 hours
<b>150°C</b>		30 minutes	1 hour	1 hour	1 hour

Note: Additional information may be available on the technical datasheet. This chart contains typical property values and actual values or results may vary.

<sup>(1)</sup> Cure inhibition may be a concern for addition cure RTV's. Please reference the FAQ page for more information on this phenomenon.

Two-Part Addition Cure<sup>(1)</sup>

	OPTICALLY CLEAR			UL94 V-0		SPECIALTY
	RTV615	RTV656	RTV655	RTV627	RTV6428	FRV138
<b>Features</b>	Low viscosity, heat curing sealant with the capability to cure at room temperature. Provides virtually unlimited depth of cure, even in completely enclosed assemblies and offers easy repairability. FDA compliance capability.	Heat curing sealant with the capability to cure at room temperature. Provides virtually unlimited depth of cure, even in completely enclosed assemblies.	Heat curing sealant with the capability to cure at room temperature. Provides virtually unlimited depth of cure, even in completely enclosed assemblies.	Low viscosity sealant which offers deep section cure capabilities. UL94 V-0 recognition; Reversion resistant; Hydrolytically stable.	Fast curing, low viscosity sealant. UL94 V-0 recognition.	Flowable, two-component, fluorosilicone encapsulant that can offer a low temperature cure and excellent chemical resistance.
<b>Typical Applications (Include but not limited to)</b>	Solar potting; Optical instruments; Cell phone solar instruments; Cell phone solar batteries; Gasketing; Applications requiring visual identification of potted assemblies; Electrical insulation; Applications requiring shock resistance; Applications in high humidity environments.	Solar potting; Optical instruments; Cell phone solar batteries; Gasketing; Applications requiring visual identification of potted assemblies; Electrical insulation; Applications requiring shock resistance; Applications in high humidity environments.	Solar potting; Optical instruments; Cell phone solar batteries; Gasketing; Applications requiring visual identification of potted assemblies; Electrical insulation; Applications requiring shock resistance; Applications in high humidity environments.	Production line potting compounds; Encapsulation of high voltage transformers, voltage regulators, power converters; Complete power supplies, Flyback transformers.	Encapsulation; Potting; High voltage transformers; Voltage regulators; Power converters.	Applications requiring resistance to the swelling effects of fuels, oils, solvents and other chemicals.
<b>Key Substrate Adhesion</b>	May require a primer for adhesion.	May require a primer for adhesion.	May require a primer for adhesion.	May require a primer for adhesion.	May require a primer for adhesion.	Primerless adhesion to many metals, plastics and glass.
<b>Mix Ratio (base to curing agent by weight)</b>	10 : 1	10 : 1	10 : 1	1 : 1	1 : 1	1 : 1
<b>Color (Final Product)</b>	Translucent	Translucent	Translucent	Dark Gray	Dark Gray	Translucent
<b>Viscosity (cps)</b>	4,000	5,000	5,200	1,300	1,400	FRV138A: 11,500 FRV138B: 8,000
<b>Useful Temperature Range</b>	-60 to 205°C (-75 to 400°F)	-115 to 205°C (-175 to 400°F)	-115 to 205°C (-175 to 400°F)	-60 to 205°C (-75 to 400°F)	-60 to 205°C (-75 to 400°F)	-60 to 205°C (-75 to 400°F)
<b>Specific Gravity</b>	1.02	1.03	1.04	1.37	1.37	1.30
<b>Hardness, Shore A Durometer</b>	44	44	45	62	62	-
<b>Hardness, Shore 00 Durometer</b>	-	-	-	-	-	55
<b>Tensile Strength (psi)</b>	920	920	920	475	475	44
<b>Elongation (%)</b>	120	100	120	60	60	73
<b>Thermal Conductivity (W/mK)</b>	0.15	0.19	0.11	0.31	0.31	-
<b>Coefficient of Thermal Expansion (Linear CTE, cm/cm °C (in/in °F))</b>	27 x 10 <sup>-5</sup> (15.3 x 10 <sup>-5</sup> )	33 x 10 <sup>-5</sup> (18.3 x 10 <sup>-5</sup> )	33 x 10 <sup>-5</sup> (18.3 x 10 <sup>-5</sup> )	21 x 10 <sup>-5</sup> (11.4 x 10 <sup>-5</sup> )	21 x 10 <sup>-5</sup> (11.4 x 10 <sup>-5</sup> )	630 ppm/°C
<b>Dielectric Strength (75 mils, V/mil)</b>	500	500	500	510	530	-
<b>Dielectric Constant (1 kHz)</b>	2.70	2.69	2.69	2.97	3.00	7.2
<b>Dissipation Factor (1 kHz)</b>	0.0006	0.0004	0.0004	0.0060	0.0061	-
<b>Volume Resistivity (ohm-cm)</b>	1.8 x 10 <sup>15</sup>	1.2 x 10 <sup>15</sup>	1.2 x 10 <sup>15</sup>	5.7 x 10 <sup>14</sup>	5.7 x 10 <sup>14</sup>	1.6 x 10 <sup>10</sup>
<b>Processing:</b>						
<b>Work (Pot) Life @ 25°C (77°F)</b>	4 hours	4 hours	4 hours	2 hours	4 minutes	> 8 hours
<b>Cure Time @</b>						
<b>25°C</b>	7 hours	7 days	7 days	2 days	30 minutes	-
<b>65°C</b>	4 hours	4 hours	4 hours	4 hours	15 minutes	-
<b>90°C</b>	-	-	-	-	-	1 hour
<b>100°C</b>	1 hour	1 hour	1 hour	1 hour	10 minutes	-
<b>125°C</b>	45 minutes	45 minutes	45 minutes	45 minutes	5 minutes	-
<b>150°C</b>	15 minutes	15 minutes	15 minutes	15 minutes	2 minutes	-

Note: Additional information may be available on the technical datasheet. This chart contains typical property values and actual values or results may vary.

<sup>(1)</sup> Cure inhibition may be a concern for addition cure RTVs. Please reference the FAQ page for more information on this phenomenon.

Thermally Conductive Adhesives and Sealant<sup>(1)</sup>

	1 PART CONDENSATION CURE		1 PART ADDITION CURE				2 PART ADDITION CURE	
	FAST TACK FREE TIME		THIN BOND LINE CAPABILITY				UL94 V-0	GELS
	XE11-B5320	TSE3941	SilCool* LTR3292	SilCool* LTR3295	TSE3281-G	TSE3280-G	TSE3331	TSE3080
<b>Features</b>	Low volatile, paste adhesive. Thermal conductivity of 1.3 W/mK.	Paste adhesive with UL94 V-1 recognition. Thermal conductivity of 0.83 W/mK.	Low thermal resistance, flowable, thermal silicone adhesive. Excellent dielectric properties. Thermal conductivity of 1.8 W/mK.	Fast cure, low viscosity, thermally conductive adhesive that can offer excellent die shear adhesion <sup>4</sup> . Thermal conductivity of 1.8 W/mk.	Flowable, heat curing adhesive offering excellent dielectric properties. Thermal conductivity of 1.7 W/mK.	Semi-flowable, heat curing adhesive. Thermal conductivity of 0.88 W/mK.	Flowable adhesive with long thermal conductive performance and a long pot life at 23°C. Mix ratio of 1:1. UL94 V-0 recognition. Thermal conductivity of 0.63 W/mK.	Thermally conductive, flowable, heat curing gel. Mix ratio of 1:1. Thermal conductivity of 0.63 W/mK.
<b>Typical Applications (include but not limited to)</b>	Board level assembly and component sealing/repair that requires moderate thermal management performance.	Board level assembly and component sealing/repair that requires moderate thermal management performance.	Thermal interface between high performance devices and heat dissipation devices (heat sinks); TIM1/TIM2 applications.	Electrical and electronic applications where high thermal transfer is required; TIM1/TIM2 applications.	Thermal interface adhesive for medium performance CPU's and general heat dissipation in board assemblies.	Thermal interface adhesive for medium performance CPU's and general heat dissipation in board assemblies.	Heat-generating electronic components; Potting and encapsulating applications; Moisture and vibration protection in power modules, converters, IGBT's, and other sensitive devices.	Heat-generating electronic components; Potting and encapsulating applications; Moisture and vibration protection in power modules, converters, IGBT's, and other sensitive devices.
<b>Color (Final Product)</b>	White	White	Gray	Gray	Gray	Gray	Dark Gray	Black
<b>Viscosity (cps)</b>	-	-	30,000	30,000	40,000	60,000	3,500	7,000
<b>Tack Free Time</b>	5 minutes	5 minutes	-	-	-	-	-	-
<b>Thermal Conductivity<sup>1</sup> (W/mK)</b>	1.3	0.83	1.8	1.8	1.68	0.88	0.63	0.63
<b>Thermal Resistance<sup>2</sup> (mm<sup>2</sup>-K/W)</b>	-	-	25 (40 µm)	37 (50µm)	35 (50 µm)	-	-	-
<b>Useful Temperature Range</b>	-55 to 200°C (-67 to 392°F)	-55 to 200°C (-67 to 392°F)	-60 to 205°C (-75 to 400°F)	-60 to 205°C (-75 to 400°F)	-55 to 200°C (-67 to 392°F)	-55 to 200°C (-67 to 392°F)	-55 to 200°C (-67 to 392°F)	-50 to 200°C (-58 to 392°F)
<b>Specific Gravity</b>	2.59	1.65	2.62	2.60	2.70	2.10	1.51	1.53
<b>Hardness, Shore A Durometer</b>	80	65	83	91	84	62	60	20 (penetration)
<b>Tensile Strength (psi)</b>	522	421	375	750	654	470	421	-
<b>Elongation (%)</b>	40	100	40	39	50	110	70	-
<b>Coefficient of Thermal Expansion (ppm/K)</b>	190	160	-	1.30 ppm/°C	1.4 x 10 <sup>-4</sup> cm/cm °C	2.2 x 10 <sup>-4</sup> cm/cm °C	170	-
<b>Glass Transition Temp</b>	-	-	-120	-	-120	-	-	-
<b>Volume Resistivity<sup>3</sup> (ohm-cm)</b>	2.0 x 10 <sup>15</sup>	4.0 x 10 <sup>14</sup>	4.6 x 10 <sup>15</sup>	-	4.8 x 10 <sup>14</sup>	2.5 x 10 <sup>14</sup>	2 x 10 <sup>14</sup>	1.0 x 10 <sup>15</sup>
<b>Dielectric Strength (kV/mm)</b>	17	22	17	-	15	21	26	22
<b>Work (Pot) Life @ 23°C</b>	-	-	8 hours	24 hours	-	-	8 hours	3 hours
<b>Cure Time<sup>+</sup></b>								
<b>25°C</b>	24 hours	24 hours	-	-	2 hours at 100°C	2 hours at 100°C	-	48 hours
<b>80°C</b>	-	-	-	30 minutes	-	-	-	-
<b>120°C</b>	-	-	-	-	45 minutes at 125°C	45 minutes at 125°C	1 hour	100°C for 1 hour
<b>150°C</b>	-	-	1 hour	10 minutes	30 minutes	30 minutes	-	-

Note: Additional information may be available on the technical datasheet. This chart contains typical property values and actual values or results may vary.

1 Bulk sample measurement (Hot wire method).

2 Laser flash analysis on a Si-Si sandwiched material.

3 ASTM E14561 method utilized.

4 Testing done on assemblies of silicon die to chromate-coated aluminum panels. 10-psi pressure. 1-2 mil bondline thickness. Typical adhesion values are 800psi after 30 minutes of cure at 80°C. Dage 4000.

<sup>(1)</sup> See Thermal Management Silicones for Electronics Brochure for additional technical information.

+ Actual cure time will depend on the cross-sectional thickness of the silicone adhesive, the thermal properties of the overall assembly, and the type and efficiency of the oven used.



## Thermally Conductive Greases

Typical applications include but are not limited to: Heat management; Automated dispensing; Screen printing and stamping applications.

	LOW VOLATILE	
	SilCool* TIG2000	YG6260
Features	Outstanding dielectric properties; Excellent workability; Minimal weight loss at elevated temperatures. MIL-S-8660. Thermal conductivity of 2 W/mK.	Higher temperature performing dielectric compound. Thermal conductivity of 0.84 W/mK.
Color (Final Product)	Pale Blue	White-opaque
Thermal Conductivity (W/mK)	2	0.84
Thermal Resistance (mm <sup>2</sup> -K/W)	24 (@ 50 μm)	-
Useful Temperature Range	-50 to 170°C (-58 to 338°F)	-50 to 150°C (-58 to 302°F)
Specific Gravity	2.80	2.50
Penetration @ 23°C (worked)	400	300
Bleed (150°C, 24 hours, wt %)	<0.1	0.2
Evaporation (150°C, 24 hours, %)	<0.1	0.1
Volume Resistivity (ohm-cm)	1.0 x 10 <sup>14</sup>	2.0 x 10 <sup>14</sup>
Dielectric Strength (kV/0.25 mm)	<100	-

Note: Additional information may be available on the technical datasheet. This chart contains typical property values and actual values or results may vary.

## Semiconductor Die-Attach Adhesives and Encapsulants

	ELECTRICALLY CONDUCTIVE	OPTICALLY CLEAR	SEMI-CONDUCTIVE ADHESIVE
	SIFas* SDC5000	XE5844	CRTV5120
Features	1-part, fast, heat curable paste adhesive. Outstanding thermal stability, low stress, and low moisture absorption. Thermal conductivity of 3.1 W/mK.	Translucent, junction coating rubber offering a high refractive index (n <sub>D</sub> <sup>25</sup> = 1.507) and a long pot life. Mix ratio of 1:1.	One-part, fast cure, acetoxy paste adhesive. Tack free time of 20 minutes. Primerless adhesion to many metals, plastics, and glass.
Typical Applications (include but not limited to)	Attachment of integrated circuits and components to a variety of substrates. Offers excellent adhesion on organic and metal surfaces, including soldermask, gold and polyimide.	Optical fiber coating; Optical devices.	Sealing and bonding.
Color (Final Product)	Yellow	Translucent	Black
Viscosity (cps)/Application Rate (g/min)	16,000 cps	2,000 cps	550 g/min (paste)
Thermal Conductivity (W/mK)	3.1	0.18	-
Useful Temperature Range	-60 to 205°C (-75 to 400°F)	-60 to 205°C (-75 to 400°F)	-60 to 205°C (-75 to 400°F)
Specific Gravity	3.77	1.07	1.07
Hardness, Shore A Durometer	65	15	35
Tensile Strength (psi)	174	29	265
Elongation (%)	200	100	420
Volume Resistivity (ohm-cm)	2 x 10 <sup>-4</sup>	-	5 x 10 <sup>2</sup>
Dielectric Strength (kV/mm)	-	-	-
Dielectric Constant (60 Hz)	-	-	-
Dielectric Factor (60 Hz)	-	-	-
Ionic Content (Na, K, Cl, ppm)	each <5	<2, <2, -	-
Work (Pot) Life @ 23°C	-	6 hours	-
Cure Time @			
25°C	-	-	24 hours
120°C	-	-	-
150°C	1 hour	30 minutes	-

Note: Additional information may be available on the technical datasheet. This chart contains typical property values and actual values or results may vary.

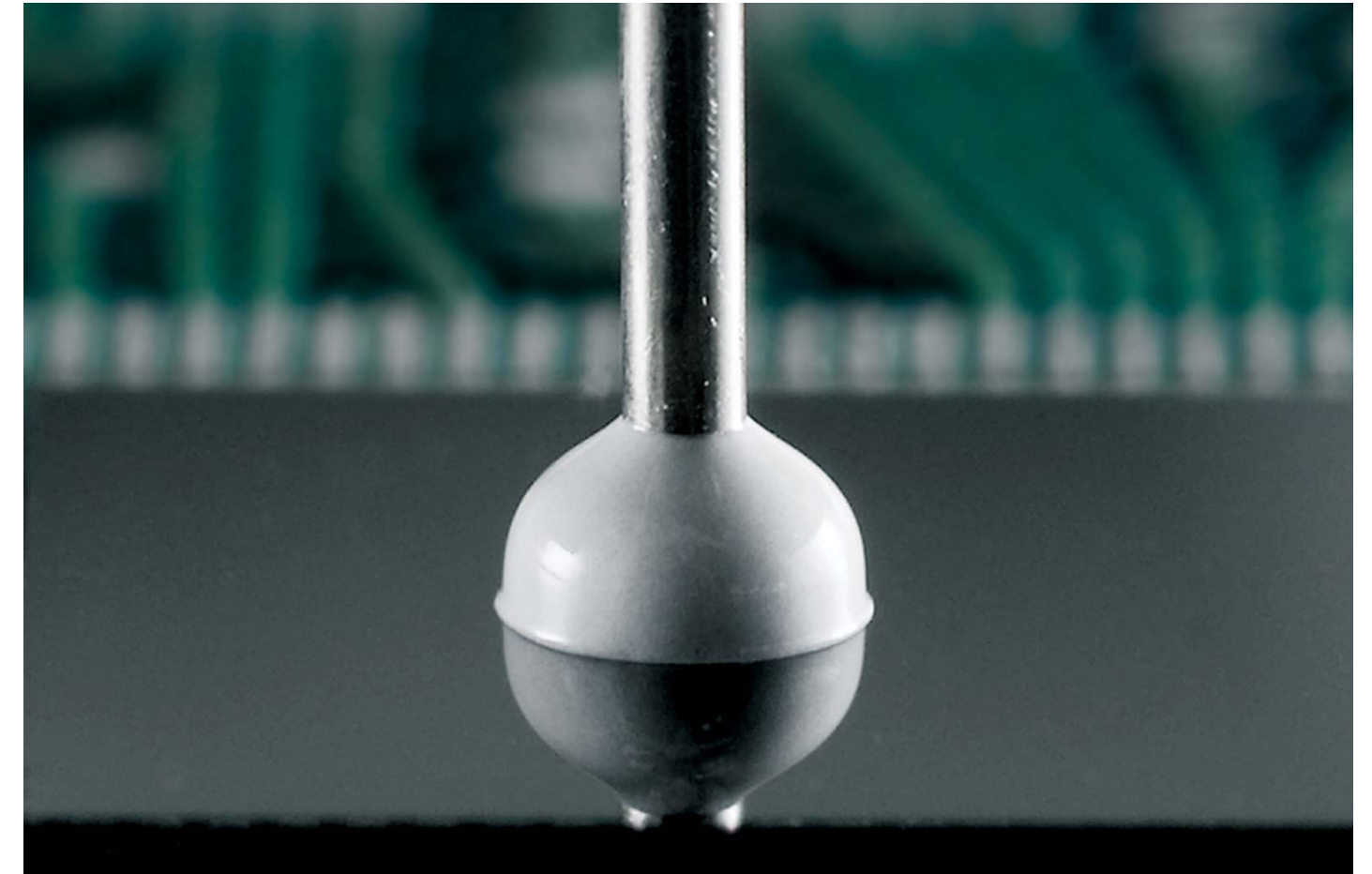

GELS

Our gels may preserve dielectric integrity and protection of delicate electronic circuit assemblies operating in harsh environments. They can offer external shock and vibration protection/ dampening, mechanical cushioning, excellent moisture protection and low shrinkage, and they are self-healing.

	2 PART ADDITION CURE						1 PART ADDITION CURE		
	RTV6100A <sup>(1)</sup>	RTV6136-D1	RTV6156	RTV6166	RTV6186	RTV6196	TSE3070	TSE3051	UL94 V-1 TSE3051FR
<b>Features</b>	Base component for RTV61XX series. May be suitable for applications requiring additional "Part A" for off ratio mixing; Yields a softer gel with a higher penetration value.	High strength, fast cure, tough gel; Good tear resistance; Requires the use of automated meter-mix dispensing equipment.	High performance gel which offers low temperature performance.	General purpose gel.	High strength, fast heat curing, tough gel; Good tear resistance; Extended room temperature pot-life (8+ hours) can benefit use on non-automated production lines.	Fast curing, low viscosity silicone gel; Requires the use of dispensing equipment.	Low viscosity, high elongation gel.	Fast heat curing, low viscosity potting gel.	Flame retardant, fast heat curing, low viscosity potting gel. UL94 V-1 recognition at 3.0mm.
<b>Mix Ratio (base to curing agent by weight)</b>	1:1	1:1	1:1	1:1	1:1	1:1	1:1	1-component	1-component
<b>Color (Final Product)</b>	Translucent	Translucent	Translucent	Translucent	Translucent	Translucent	Translucent	Translucent	Translucent
<b>Viscosity (cps)</b>	750	750	750	750	750	750	800	700	700
<b>Useful Temperature Range</b>	-50 to 205°C (-58 to 400°F)	-50 to 205°C (-58 to 400°F)	-115 to 205°C (-175 to 400°F)	-50 to 205°C (-58 to 400°F)	-50 to 205°C (-58 to 400°F)	-50 to 205°C (-58 to 400°F)	-50 to 205°C (-58 to 400°F)	-50 to 200°C (-58 to 392°F)	-50 to 200°C (-58 to 392°F)
<b>Specific Gravity</b>	-	0.98	0.98	0.98	0.98	0.98	0.98	0.97	0.97
<b>Refractive Index</b>	-	1.406	1.430	1.406	1.406	1.406	1.404	1.404	1.404
<b>Hardness, Penetration (mm)</b>	-	6.0	4.0	6.0	6.0	6.0	-	-	-
<b>Hardness, Penetration, ASTM D 1403 (mm)</b>	-	-	-	-	-	-	65	85	85
<b>Thermal Conductivity (W/mK)</b>	-	0.19	0.19	0.19	0.19	0.19	0.17	0.17	0.17
<b>Coefficient of Thermal Expansion (Linear CTE, cm/cm °C (in/in °F))</b>	-	27 x 10 <sup>-5</sup> (15.3 x 10 <sup>-5</sup> )	27 x 10 <sup>-5</sup> (15.3 x 10 <sup>-5</sup> )	27 x 10 <sup>-5</sup> (15.3 x 10 <sup>-5</sup> )	27 x 10 <sup>-5</sup> (15.3 x 10 <sup>-5</sup> )	27 x 10 <sup>-5</sup> (15.3 x 10 <sup>-5</sup> )	-	-	-
<b>Cubical Expansion (I/°C)</b>	-	-	-	-	-	-	0.56 x 10 <sup>-3</sup>	0.56 x 10 <sup>-3</sup>	0.56 x 10 <sup>-3</sup>
<b>Dielectric Strength (75 mils, kV/mm, V/mil)</b>	-	20.5 (500)	20.5 (500)	20.5 (500)	20.5 (500)	20.5 (500)	18 (400)	18 (400)	18 (400)
<b>Dielectric Constant (1 kHz)</b>	-	2.8	2.8	2.8	2.8	2.8	2.7	2.8	2.8
<b>Dissipation Factor (1 kHz)</b>	-	0.001	0.001	0.001	0.001	0.001	0.002	0.001	0.001
<b>Volume Resistivity (ohm-cm)</b>	-	1.0 x 10 <sup>15</sup>	1.0 x 10 <sup>15</sup>	1.0 x 10 <sup>15</sup>	1.0 x 10 <sup>15</sup>	1.0 x 10 <sup>15</sup>	1.0 x 10 <sup>15</sup>	1.0 x 10 <sup>15</sup>	1.0 x 10 <sup>15</sup>
<b>Processing Work (Pot) Life @ 23°C</b>	-	30 minutes	1 hour	2 hours	> 8 hours	15 minutes	4 hours	2 weeks	2 weeks
<b>Cure Time 25°C</b>	-	< 4 hours	< 18 hours	< 24 hours	-	< 2 hours	< 24 hours	-	-
<b>65°C</b>	-	2 hours	4 hours	4 hours	4 hours	1 hour	45 minutes	-	-
<b>100°C</b>	-	20 minutes	1 hour	1 hour	1 hour	10 minutes	-	3 hours	3 hours
<b>125°C</b>	-	-	-	-	-	-	-	2 hours	2 hours
<b>150°C</b>	-	10 minutes	15 minutes	15 minutes	15 minutes	5 minutes	-	1 hour	1 hour

Note: Additional information may be available on the technical datasheet. This chart contains typical property values and actual values or results may vary.

<sup>(1)</sup> Not intended for use with RTV6156 which was designed for low temperature performance. Changes to the mix ratios can either shorten or lengthen the pot life of the catalyzed mixture.

### InvisiSil\* LED and Optoelectronics Encapsulants<sup>(1)</sup>

Two-part, optically clear, heat curable gels or elastomers. Typical silicone benefits include non-yellowing, high light transmittance, and a high refractive index for LED chip encapsulation. Other applications may include, but are not limited to: coating optical devices and semi-conductors; absorbing shock and protecting delicate mechanical components from vibration.

	2 PART ADDITION CURE					
	IVS4012	IVS4312	IVS4632	IVS5022	IVS5332	IVSM4500 <sup>(2)</sup>
Mix Ratio (base to curing agent by weight)	1:1	1:1	1:1	1:1	1:1	1:1
Color (Final Product)	Transparent	Transparent	Transparent	Transparent	Transparent	Transparent
Viscosity After Mix @ 23°C (cps)	800	1,000	3,200	2,200	3,300	30,000
Useful Temperature Range	-50 to 205°C (-58 to 400°F)	-50 to 205°C (-58 to 400°F)	-50 to 205°C (-58 to 400°F)	-50 to 205°C (-58 to 400°F)	-50 to 205°C (-58 to 400°F)	-50 to 205°C (-58 to 400°F)
Refractive Index (n <sub>D</sub> <sup>25</sup> )	1.40	1.41	1.41	1.51	1.53	1.41
Penetration (JIS K 6249, mm)	57	-	-	34	-	-
Hardness, Shore A Durometer	-	29	64	-	30	97
Tensile (MPa)	-	0.8	9.0	-	0.3	4.7
Elongation (%)	-	110	80	-	50	<5
Specific Gravity @ 23°C	0.98	0.99	1.05	1.06	1.12	1.10
Adhesion Strength (PPA, MPa)	-	0.2	2.7	-	0.3	-
Processing						
Work (Pot) Life @ 23°C	4 hours	6 hours	8 hours	8 hours	8 hours	24 hours
Cure Time						
70°C	30 minutes	-	-	-	-	-
150°C	-	1 hour	1 hour	1 hour	1 hour	1 hour <sup>(3)</sup>

Note: Additional information may be available on the technical datasheet. This chart contains typical property values and actual values or results may vary.

<sup>(1)</sup> Please see Silicone Material Solutions for LED Packages and Assemblies brochure for more detailed technical information.

<sup>(2)</sup> IVSM4500 is generally suitable for injection molding of optical parts such as LED lenses.

<sup>(3)</sup> If cast molded.

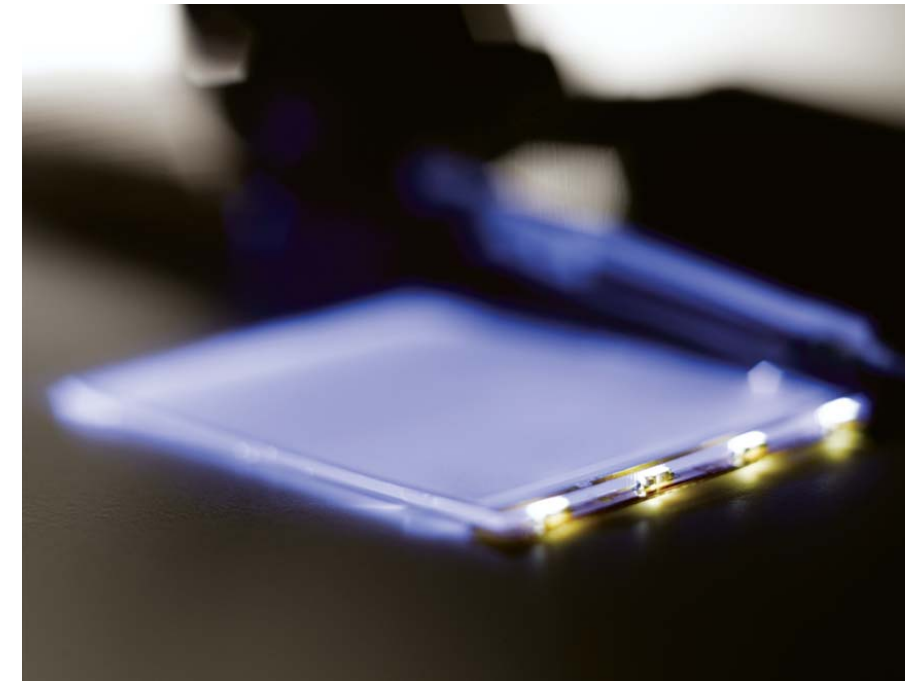

### Silicone Liquid Elastomers (SLE)

Typical applications include but are not limited to: Industrial, medical, and structural fabrics; Electrical sleeving; Performance outerwear; Airbag coatings; Protective blankets and Belting.

	SLE5500	SLE5401	SLE5600	SLE5700-D1	SLE7000
Features	High viscosity, low durometer. FDA compliance capability.	Excellent adhesion to synthetic fabrics while providing durable antiblocking characteristics.	High strength and abrasion resistance. FDA compliance capability.	Typically enhances the physical strength of engineered textiles while providing durable antiblocking characteristics.	Medium viscosity silicone liquid elastomer that can be applied in thin films and cured rapidly. Typically enhances the physical strength of textiles.
Key Substrate Adhesion	Primarily mechanical adhesion. May require the use of a primer for chemical adhesion.	Nylon, kevlar, fiberglass, polypropylene, polyethylene, natural fibers and other industrial and structural fabrics.	Primarily mechanical adhesion. May require the use of a primer for chemical adhesion.	Natural fabrics and fiberglass.	Nylon, kevlar, fiberglass, polypropylene, polyethylene, natural and structural fabrics.
Color (Final Product)	White	Translucent	Beige	Translucent	Translucent
Mix Ratio (base to curing agent by weight)	10:1	1:1	1:1	1:1	1:1
Viscosity (cps)	100,000	25,000	150,000	20,000	200,000
Useful Temperature Range	-60 to 232°C (-75 to 450°F)	-60 to 205°C (-75 to 400°F)	-60 to 205°C (-75 to 400°F)	-60 to 205°C (-75 to 400°F)	-60 to 205°C (-75 to 400°F)
Specific Gravity	1.17	1.01	1.27	1.01	1.06
Hardness, Shore A Durometer	27	45	58	40	34
Tensile (psi)	190	800	790	500	550
Elongation (%)	280	200	220	200	375
Work (Pot) Life @ 25°C	48 hours	8 hours	48 hours	48 hours	8 hours
Cure Time (Thin Films)	1 minute @ 205°C	1 - 2 minutes @ 150°C	1 minute @ 205°C	1 - 2 minutes @ 160°C	1 - 2 minutes @ 150°C

Note: Additional information may be available on the technical datasheet. This chart contains typical property values and actual values or results may vary.

Foams and Foamable Products

	RTF7000	RTF762 <b>UL94 V-0</b>	RTF8510	<b>REQUIRES AUTOMATED EQUIPMENT</b> RTF5308
<b>Features</b>	Multi component foam for the design of finished foam products with a wide range of density cell structure and physical properties; Non halogenated fire retardancy; Low smoke generation; Low toxicity combustion byproduct; Room temperature process capable.	Medium density flexible foam; Pigmentable; UL94 V-0 recognition (6.44 mm thick).	Medium density flexible foam; Room temperature cure; Low viscosity; Resists cracking and splitting after cure.	Fast curing, paste adhesive. Capable of being mechanically foamed.
<b>Typical Applications (include but not limited to)</b>	Thermal insulation and cast in place thermal insulation; Applications requiring flame retardancy and/or low density.	Cast in place thermal insulation; Small molded parts; Foam/foil laminates for heat management; Sheet stock for firewall application and die gaskets; Sound dampening.	Pour-in-place thermal insulation; Sprayable insulation; Mechanical cushioning; Fire stop system; Vibration dampening, sound deadening; Molding parts.	Formed-in-place gaskets; Vertical and Horizontal applications; Hot/Cold thermal cycles; Expandable silicone foam per GM2224M2D2CF1, Type II.
<b>Key Substrate Adhesion</b>	May require a primer for adhesion.	Primerless adhesion to many metals, plastics and glass.	Primerless adhesion to many metals, plastics and glass.	Primerless adhesion to many metals, plastics, masonry, wood, glass and ceramics. Not recommended for use on polycarbonates and acrylics.
<b>Color (Final Product)</b>	Off-white	Off-white	Black	Translucent
<b>Mix Ratio (base to curing agent by weight)</b>	Variable	10:1	1:1	One-part
<b>Viscosity (cps)/ Application Rate (g/min)</b>	Base: 65,000 cps	RTF762A: 65,000 cps RTF762B: 1,500 cps	RTF8510A: 9,000 cps RTF8510B: 6,000 cps	290 g/min
<b>Work Time</b>	1 to 4 minutes	3.5 minutes	3 minutes	-
<b>Expansion Ratio</b>	Varies	4:1	4:1	-
<b>Time for Full Rise</b>	5 to 23 minutes	20 minutes	20 minutes	-
<b>Density (lb/ft<sup>3</sup>)</b>	Varies	15	16	-
<b>Tensile Strength (psi)</b>	Varies	75	-	305
<b>Elongation (%)</b>	Varies	90	-	485
<b>25% Compression Deflection (lb/in<sup>2</sup>)</b>	Varies	6	-	-
<b>Thermal</b>				
Thermal Conductivity (BTU in/hr, ft <sup>2</sup> , °F/ft)	0.38	0.44	0.44	-
<b>Flammability</b>				
Limiting Oxygen Index	-	30	30	-
ASTM E-162 Radiant Panel Flame spread index	-	16	18	-
ASTM E-662/NFPA 258 Smoke Density	17	18	41	-
<b>Smoldering (4 minutes)</b>	-	9	70	-
<b>FAA25.853 (b) Vertical Burn</b>	Pass	Pass	-	-
<b>Useful Temperature Range</b>	-52 to 162°C (-62 to 324°F)	-60 to 205°C (-75 to 400°F)	-60 to 205°C (-75 to 400°F)	-60 to 205°C (-75 to 400°F)

Note: Additional information may be available on the technical datasheet. This chart contains typical property values and actual values or results may vary.

Mold Making Products

2 PART CONDENSATION CURE									
	RTV421	RTV426			RTV430		RTV7888-20		
<b>Features</b>	Low durometer, good pour. Good resistance to polyurethane resins.	Excellent resistance to polyurethane. Flexible catalyst system.			High durometer, low viscosity. Can be used/customized with two different catalysts.		Mid durometer with excellent resistance to polyester. Offers a variety of curing options.		
<b>Typical Applications (include but not limited to)</b>	Art Reproduction	Art Reproduction; Architectural and Furniture Molding			Art Reproduction		Art Reproduction; Architectural and Furniture Molding		
<b>Catalyst</b>	Beta 16 Mixed at 10:1 wt %	Beta 26 Mixed at 3 wt. %	Beta 26 Mixed at 5 wt. %	Beta 26 Mixed at 7 wt. %	Beta 5 Mixed at 10:1 wt. %	Beta 11 Mixed at 10:1 wt. %	Beta 16 Mixed at 10:1 wt. %	Beta 17 Mixed at 40:1 wt. %	Beta 18 Mixed at 10:1 wt. %
<b>Color (Final Product)</b>	Beige (base) Red (catalyst) Pink (mixed)	Beige (base) Green (catalyst) Lt. Green (mixed)	Beige (base) Green (catalyst) Med. Green (mixed)	Beige (base) Green (catalyst) Dk. Green (mixed)	White (base) Red (catalyst) Pink (mixed)	White (base) Blue (catalyst) Lt. Blue (mixed)	White (base) Red (catalyst) Pink (mixed)	White (base) Clear (catalyst) White (mixed)	White (base) Red (catalyst) Pink (mixed)
<b>Viscosity (cps)</b>	40,000 (base) 30 (catalyst) 29,000 (mixed)	40,000 (base) 20 (catalyst) 37,000 (mixed)	40,000 (base) 20 (catalyst) 35,500 (mixed)	40,000 (base) 20 (catalyst) 32,000 (mixed)	55,000 (base) 50 (catalyst) 47,000 (mixed)	55,000 (base) 20 (catalyst) 47,000 (mixed)	42,584 (base) 30 (catalyst) 30,000 (mixed)	42,584 (base) 20 (catalyst) 40,000 (mixed)	42,584 (base) 30 (catalyst) 30,000 (mixed)
<b>Useful Temperature Range</b>	-51 to 205°C (-60 to 400°F)	-51 to 205°C (-60 to 400°F)	-51 to 205°C (-60 to 400°F)	-51 to 205°C (-60 to 400°F)	-51 to 205°C (-60 to 400°F)	-51 to 205°C (-60 to 400°F)	-51 to 205°C (-60 to 400°F)	-51 to 205°C (-60 to 400°F)	-51 to 205°C (-60 to 400°F)
<b>Specific Gravity</b>	1.29 (base) 0.97 (catalyst) 1.25 (mixed)	1.10 (base) 1.05 (catalyst) 1.11 (mixed)	1.10 (base) 1.05 (catalyst) 1.11 (mixed)	1.10 (base) 1.05 (catalyst) 1.11 (mixed)	1.08 (base) 1.22 (catalyst) 1.08 (mixed)	1.08 (base) 0.95 (catalyst) 1.06 (mixed)	1.25 (base) 0.98 (catalyst) 1.22 (mixed)	1.25 (base) 0.95 (catalyst) 1.24 (mixed)	1.25 (base) 0.98 (catalyst) 1.22 (mixed)
<b>Work Life</b>	60 minutes	126 minutes	68 minutes	43 minutes	90 minutes	70 minutes	60 minutes	12 minutes	60 minutes
<b>Pot Life</b>	90 minutes	258 minutes	121 minutes	76 minutes	180 minutes	90 minutes	90 minutes	15 minutes	90 minutes
<b>Demold Time (hours)</b>	12	>7	4.6	3.6	14	12	12	1	12
<b>Hardness, Shore A (24 hrs / 36 hrs)</b>	16/18	21	25	28	28/30	28/30	20	19	14
<b>Tensile Strength (psi)</b>	530	447	487	546	450	600	500	500	400
<b>Elongation (%)</b>	430	321	309	257	300	360	350	350	400
<b>Tear Strength (ppi)</b>	130	114	137	118	130	120	130	130	115
<b>Linear Shrinkage (% , 24 hrs, 7 days)</b>	0.2 / 0.5	0.05 / 0.05	0.03 / 0.48	0.1 / 1.2	0.5 / 1.0	0.5 / 1.0	0.14 / 0.43	0.11 / 0.14	0.23 / 0.06
<b>Cure Time 25°C</b>	24 hours	24 hours	24 hours	12 to 15 hours	24 hours	24 hours	24 hours	3 to 4 hours	24 hours

Note: Additional information may be available on the technical datasheet. This chart contains typical property values and actual values or results may vary.

Mold Making Accessory Products

Catalysts

	BETA 5	BETA 11-D1	BETA 16	BETA 17	BETA 18	BETA 26
<b>Features</b>	High temperature catalyst. This catalyst is not resistant to sulfur based clays. Generally suitable for jewelry molding and spin molding.	This catalyst is not resistant to sulfur-based clays.	Use of Beta 16 typically results in durometers 4 to 6 points higher than Beta 18. Generally suitable for use with sulfur-based clays.	Generally suitable for use with sulfur-based clays. Generally suitable for brush and lay-up molding.	Generally suitable for use with sulfur-based clays.	Very flexible, giving a range of durometers from 20 to 28 Shore A and fast demold times by adjusting the catalyst level. Suitable for use with sulfur-based clays. May be best suited for polyurethane casting resins.
<b>Color</b>	Red	Blue	Red	Clear	Red	Green
<b>Viscosity (cps)</b>	50	20	30	20	30	20
<b>Specific Gravity</b>	1.22	0.95	0.98	0.95	0.98	1.05
<b>Work Life</b>	45 minutes	70 minutes	60 minutes	8 to 12 minutes	60 minutes	Variable
<b>Demold Time (hours)</b>	12 to 16 hours	12 hours	12 to 16 hours	1 hour	12 to 16 hours	Variable
<b>Cure Time</b>	24 hours	24 hours	24 hours	3 to 4 hours	24 hours	< 24 hours

This chart contains typical property values and actual values or results may vary.

Primer and Additives

	SF1188A	SF97-50
<b>Features</b>	Thixotropic agent for condensation cure products. Add ~3% by weight to the base and allow to sit for ~5 minutes. This product is typically used to allow the silicone to be brushed onto vertical surfaces. There is typically no impact to the cure rate.	Dilutant to add more customization to durometer. Sometimes used as a mold lubricant. Can add up to ~7% by weight to the base without significantly impacting the physical properties.
<b>Color</b>	Clear to straw	Clear liquid
<b>Viscosity @ 25°C (CSTKS)</b>	800 to 1400	47.5 to 52.5
<b>Specific Gravity @ 25°C</b>	1.04	0.956 to 0.964
<b>Flash Point</b>	>100°C (212°F) <sup>+</sup>	>302°C (575°F) <sup>+</sup>

Note: Additional information may be available on the technical datasheet. This chart contains typical property values and actual values or results may vary.

<sup>+</sup> Flash point measured through a closed cup method.



Mold Making Products

	2 PART ADDITION CURE							
	RTV630	RTV662	RTV664	RTV668	TSE3453T	TSE3455T	TSE3457T	TSE3466
<b>Features</b>	High tear resistance, excellent durability.	Highest durometer and long work life. Ideal for embossing, release rolls and large molds.	High durometer and good dimensional stability. Excellent chemical and abrasion resistance. May be best suited for high production on manufacturing lines.	High durometer and good dimensional stability. May be best suited for casting with masters made of pine, oak and elm.	Easy flow, low durometer, good resistance to urethanes.	Lowest viscosity product. Excellent resistance to polyurethane.	Medium durometer, good dimensional stability.	High durometer, low viscosity.
<b>Typical Applications (include but not limited to)</b>	Art reproduction; Prototyping	Architectural and Furniture Molding	Architectural and Furniture Molding; Prototyping	Architectural and Furniture Molding	Architectural and Furniture Molding; Prototyping	Architectural and Furniture Molding; Prototyping	Prototyping	Architectural and Furniture Molding; Prototyping
<b>Catalyst</b>	RTV630B Mixed at 10:1 wt. %	RTV662B Mixed at 10:1 wt. %	RTV664B Mixed at 10:1 wt. %	RTV668B Mixed at 10:1 wt. %	TSE3453T B Mixed at 10:1 wt. %	TSE3456 C Mixed at 10:1 wt. %	TSE3457 C Mixed at 10:1 wt. %	TSE3466 B Mixed at 10:1 wt. %
<b>Color</b>	Beige (base) Blue (catalyst) Blue (mixed)	Beige (base) Blue (catalyst) Blue (mixed)	Beige (base) Blue (catalyst) Blue (mixed)	Beige (base) Green (catalyst) Green (mixed)	Translucent (base) Translucent (catalyst) Translucent (mixed)	Translucent (base) Translucent (catalyst) Translucent (mixed)	Translucent (base) Translucent (catalyst) Translucent (mixed)	Translucent (base) Translucent (catalyst) Translucent (mixed)
<b>Viscosity (cps)</b>	160,000 (base) 6,000 (catalyst) 150,000 (mixed)	150,500 (base) 5,000 (catalyst) 120,000 (mixed)	160,000 (base) 6,000 (catalyst) 110,000 (mixed)	151,000 (base) 3,800 (catalyst) 120,000 (mixed)	60,000 (base) 2,500 (catalyst) 45,000 (mixed)	45,000 (base) 1,500 (catalyst) 30,000 (mixed)	68,000 (base) 2,500 (catalyst) 45,000 (mixed)	70,000 (base) 300 (catalyst) 45,000 (mixed)
<b>Useful Temperature Range</b>	-51 to 205°C (-60 to 400°F)	-60 to 200°C (-75 to 392°F)	-60 to 200°C (-75 to 392°F)	-60 to 200°C (-75 to 392°F)	-55 to 200°C (-67 to 392°F)	-55 to 200°C (-67 to 392°F)	-55 to 200°C (-67 to 392°F)	-55 to 200°C (-67 to 392°F)
<b>Specific Gravity</b>	1.29 (base) 1.07 (catalyst)	1.28 (base) 1.05 (catalyst)	1.28 (base) 1.05 (catalyst)	1.28 (base) 1.05 (catalyst)	1.09 (base) 1.02 (catalyst)	1.10 (base) 0.99 (catalyst)	1.10 (base) 0.99 (catalyst)	1.10 (base) 1.02 (catalyst)
<b>Work Life</b>	4 hours	4 hours	2 hours	2 hours	2 hours	1.5 hour	1 hour	1.5 hours
<b>Pot Life</b>	-	5 hours	3 hours	2.5 hours	2.5 hours	2 hours	1.5 hours	2 hours
<b>Demold Time (hours)</b>	-	24	18	24	24	24	24	24 hours
<b>Hardness, Shore A Durometer</b>	60 (24 hours)	68 (36 hours)	62 (36 hours)	62 (36 hours)	40 (72 hours)	41 (72 hours)	47 (72 hours)	60 (72 hours)
<b>Tensile (psi)</b>	820	1015	933	1041	928	924	1123	1073
<b>Elongation (%)</b>	250	235	245	240	400	360	400	350
<b>Tear Strength (lb/in)</b>	110	136	122	100	143	112	191	91
<b>Linear Shrinkage (%) (24 hrs, 7 days)</b>	0.8	< 0.2	< 0.2	< 0.2	< 0.1	< 0.1	< 0.1	< 0.1
<b>Cure Time</b>								
25°C	24 hours	24 hours	24 hours	24 hours	24 hours	24 hours	24 hours	24 hours
65°C	4 hours	4 hours	4 hours	4 hours	To achieve faster cure speeds, elevated temperatures may be used.	To achieve faster cure speeds, elevated temperatures may be used.	To achieve faster cure speeds, elevated temperatures may be used.	To achieve faster cure speeds, elevated temperatures may be used.
100°C	1 hour	1 hour	1 hour	1 hour				
150°C	15 minutes	15 minutes	15 minutes	15 minutes				

Note: Additional information may be available on the technical datasheet. This chart contains typical property values and actual values or results may vary.

# Surface Preparation and Adhesion

- **What is Adhesion?**
  - Adhesion refers to the bond between two adjacent materials and is related to the force required to affect their complete separation.
- **Types of Failure:**
  - Cohesive failure (silicone breaks)
    - Adhesive ruptures leaving adhesive on both substrates involved in the bond
  - Adhesive failure (bond breaks):
    - Adhesive pulls cleanly away from the substrate
- **Why is Surface Preparation Important?**
  - Substrate preparation is critical to good adhesion
  - Poor substrate preparation can contribute to adhesion problems
  - Important to remove contamination
    - Process oils, mold release, dirt, grease, etc.
    - Can be done by:
      - ◆ Appropriate solvent cleaning
        - ★ Acetone, IPA, ethyl acetate, toluene, etc.
        - ★ Wipe, immerse
      - ◆ Detergent cleaning
        - ★ Soap and water
        - ★ Wash and water rinse, dry thoroughly
- **For Difficult to Bond to Substrates/ Surfaces:**
  - **Mechanical roughening**
    - Examples:
      - ★ Sandpaper
      - ★ Sand blasting
      - ★ Metal wool
  - **Chemical treatment**
    - Chemical treatment is the process of treating a clean surface by chemical means. The chemical nature of the substrate surface is altered to make it highly receptive to adhesion
      - ◆ Examples:
        - ★ Etching with oxalic acid/ sulfuric acid/distilled water
        - ★ Etching with hydrofluoric acid/distilled water
- **For Difficult to Bond to Substrates/ Surfaces (continued):**
  - **Use of primers**
    - One-component, no mixing required
    - Promote adhesion to difficult-to-bond substrates
    - Apply in thin coats (0.5 mil)
    - Dry at room temperature and ambient humidity conditions
      - ★ Allow the primer to air-dry for at least 30 minutes before applying silicone
      - ★ When drying, avoid touching the primer or allowing it to be exposed to dust or water
    - Primers (refer to page 39 for primer options)
  - **Flame treatment**
    - High temperature flame which oxidizes the surface of the substrate and provides new functional groups
    - Used for many types of plastics
  - **Corona treatment**
    - High voltage, high frequency discharge in air; another oxidation method, in which new functional groups are produced on the surface
  - **Plasma treatment**
    - Neutral and charged species created by a discharge in the presence of a gas

# Primers

Property	SS4004P	SS4044P	SS4120	SS4155	SS4179
Color	Pink	Clear/Amber	Clear, Colorless	Blue	Clear, Colorless
Specific Gravity	0.85	0.85	0.82	0.82	0.91
Solids Content (%)	15	15	3	10	6
Primary Solvent(s)	Acetone; Isopropanol; Xylene; N-butanol	Acetone; Isopropanol; Xylene; N-butanol	Ethanol; Methanol	Mineral Spirits	Ethyl Acetate; Toluene; Methanol
Flash Point, (Pensky-Martin Closed Cup)	-12°C (10°F)	-12°C (10°F)	-0.5°C (31°F)	37°C (98°F)	-3°C (27°F)
Dry Time <sup>(1)</sup> , colder environment (minutes)	5 to 15	5 to 15	30	30	5 to 10
Dry Time <sup>(1)</sup> , warmer environment (minutes)	3 to 5	3 to 5	–	–	3 to 5
VOC <sup>(2)</sup> (g/L)	636	624	794	765	859
D.O.T. Label	Flammable liquid	Flammable liquid	Flammable liquid	Flammable liquid	Flammable liquid

(1) Drying times shown are typical, however, these times may be longer or shorter depending upon local conditions at point of use. It is suggested to confirm that the primer is dry to the touch prior to the application of the RTV.

(2) Excluding water and exempts.

RTV Silicone Rubber Compound	Primer Suggested for Evaluation	
	Primary	Alternates
RTV11 through RTV88	SS4004P	SS4044P, SS4155
RTV500 Series	SS4004P	SS4044P, SS4155
RTV615, RTV655	SS4120	SS4155
RTV627	SS4155	SS4120
RTV630	SS4155	SS4120
RTV61X6 Series	SS4120	SS4155
RTV8000 Series	SS4004P	SS4044P

## SS4004P and SS4044P

- ✓ Helps promote adhesion to:
  - Aluminum
  - Copper
  - Steel
  - Stainless steel
  - Brass
  - Galvanized metals
  - Porous metals
  - Unglazed ceramics
  - Wood
- ✓ SS4044P is the same as SS4004P but is transparent (for applications where discoloration of the substrate is undesirable)
- ✓ SS4044P – FDA Compliance: 21 CFR 175.105 subject to the conditions and limitations of the regulation.

## SS4120

- ✓ Helps promote adhesion of addition cure RTV's
- ✓ For applications where clarity is required
- ✓ FDA Compliance: 21 CFR 175.105, 21 CFR 175.300 and 21 CFR 177.2600 subject to the conditions and limitations of the regulations.

## SS4155

- ✓ General purpose for use with any RTV

## SS4179

- ✓ Helps promote adhesion to difficult-to-bond to plastic substrates including:
  - Acrylics
  - Acrylonitrile-butadiene-styrene (ABS)
  - Cellulosics (cellulose acetate)
  - High-impact styrene
  - Thermoplastic resins
- ✓ Transparent to preserve visibility of colorless products
- ✓ FDA Compliance: 21 CFR 177.2465 subject to the conditions and limitations of the regulation.

**Caution:** Primers are flammable. Avoid flames and ensure proper ventilation when applying the primer. Transfer only the required amount to a separate container. Ensure that the unused portion is properly sealed and store in a cool, dark place. Avoid exposing the unused primer to moisture.

Note: Additional information may be available on the technical datasheet.

Typical property values and actual values or results may vary.

# Tables

- Low Volatility Grades
- UL Recognition
- Food Contact Applications:
  - FDA, USDA, NSF compliant
- Standard Methyl Silicone Chemical Resistance

## Low Volatility Grades:

Low volatility grades are developed to limit the levels of low molecular weight siloxane. Low molecular weight siloxane refers to cyclic dimethyl polysiloxane that may volatilize during and after cure.

Type	Grade
One Part	RTV142
	RTV1673LV
	XE11-B5320
Two Part	RTV566
	RTV567
One Part Grease	YG6260

## UL Directory File Number E56745: Momentive Performance Materials Japan LLC

Type	Grade	UL HB <sup>(1)</sup>	UL94-V1	UL94-V0
One Part	TSE3051FR		•	
	TSE322	•		
	TSE326	•		
	TSE382	•		
	TSE3843-W		•	
	TSE389	•		
	TSE392	•		
	TSE3941		•	
	TSE397	•		
	Two Part	TSE3331		
TSE3664				•

## UL Directory Listing File Number E36952; Plastics Component Directory

Type	Grade	UL Listed	UL HB <sup>(1)</sup>	UL94-V1	UL94-V0
One Part	IS802		•		
	IS803		•		
	IS806		•		
	IS808		•		
	IS800.09		•		
	RTV102	•			
	RTV103	•			
	RTV106	•			
	RTV108	•			
	RTV109	•			
	RTV112	•			
	RTV116	•			
	RTV118	•			
	RTV122		•		
	RTV123		•		
	RTV128		•		
	RTV133			•	•
	RTV160		•		
	RTV162		•		
	RTV167		•		
RTV5222		•			
RTV5223		•			
RTV5229		•			
RTV5812		•			
RTV5813		•			
RTV5818		•			
RTV5242		•			
RTV5243		•			
RTV5249		•			
RTV6702		•			
RTV6703		•			
RTV6708		•			
RTV230		•			
Two Part	RTV627			•	•
	RTV6428			•	•
	RTF762				•

<sup>(1)</sup> The UL94 HB rating is based on standard, small-scale laboratory tests and as such is not reliable for determining, evaluating, predicting, or describing the flammability or burning characteristics of the product under actual field conditions.

## Thermal Conductivity Unit Conversion Guide

Original Unit	Conversion Multiplier	Final Unit
W/m <sup>2</sup> K	2.4 x 10 <sup>-3</sup>	cal/cm-s°C
	6.94	BTU-in/hr-ft <sup>2</sup> °F
cal/cm-s°C	4.2 x 10 <sup>2</sup>	W/m <sup>2</sup> K
BTU-in/hr-ft <sup>2</sup> °F	0.14	W/m <sup>2</sup> K

# Food Contact Applications For Silicone Rubber Compounds

Several Momentive Performance Materials RTV silicone rubber compounds can be evaluated for food contact applications where FDA, USDA and NSF regulations apply.

## FDA STATUS

The following one-part RTV silicone rubber compounds may be used in repeated contact with foods under FDA regulation 21CFR177.2600 "Rubber Articles Intended for Repeated Use" (and, by reference, 21CFR175.300 "Resins and Polymeric Coatings").

RTV102	RTV103	RTV106
RTV108 <sup>(1)</sup>	RTV109	RTV112
RTV116	RTV118 <sup>(1)</sup>	
IS803	IS806	IS808

(1) USP Class VI

### The Use of these Sealants is Subject to the Following Conditions:

The sealant must be applied in accordance with good manufacturing practices at a thickness not to exceed 6mm (1/4") from an exposed edge, and as a continuous film between joints acting as a functional barrier between the food and the substrate (the area underneath the joint).

The sealant must be cured for a minimum of 14 days at 25°C (77°F) and 50% RH. The sealant must be thoroughly cleansed before the first use.

The sealant, when properly cured, must comply with the extractives limitations at temperatures up to and including reflux applications. The user should verify compliance with extractives limitations at higher temperatures.

Compliance with 21CFR177.2600 does not authorize use of these sealants for the manufacture of baby bottle nipples.

All previously mentioned sealants must be evaluated to determine bond strength for each specific application. If greater adhesion is required, the evaluation of primer SS4044 (clear) is recommended. SS4044 may be used in repeated contact with food under 21CFR175.105 "Adhesives" and used in conjunction with the RTV products covered under 21CFR177.2600.

The following two-part RTV silicone rubber compounds may be used in repeated contact with foods under FDA regulation 21CFR177.2600, "Rubber Articles Intended for Repeated Use"

RTV11
RTV41
RTV615
RTV664
SLE5500
SLE5600

### The Use of these Compounds is Subject to the Following Conditions:

The compound must be applied in accordance with Good Manufacturing Practices. The compound must be thoroughly cleansed before the first use. Compliance with 21CFR177.2600 does not authorize use of the compound for the manufacture of baby bottle nipples.

RTV11 and RTV41 must be formulated with Dibutyl Tin Dilaurate (DBT) or RTV9950 to comply with 21CFR175.300, 21CFR177.2600. RTV11, RTV41 and SLE5500 compounds should not be used in contact with acid foods.

As with the sealants, primers may be desired. If so, the evaluation of primers SS4044 or SS4120 is recommended. These are covered under FDA regulation 21CFR175.105 "Adhesives", and can be used in conjunction with the silicone compounds mentioned above covered under 21CFR177.2600.

## USDA STATUS

Momentive Performance Materials has on file approval letters from the USDA which states that **RTV102, RTV103, RTV106, RTV108, RTV109, RTV112, RTV116, RTV118, IS802, IS803, IS806** and **IS808** sealants, are chemically acceptable for use as sealants on equipment that may contact edible products in official establishments operating under the federal meat and poultry products inspection program. The areas sealed should be thoroughly rinsed with potable water after the sealant has properly cured. The compound must be used in a manner that prevents direct or indirect contamination of edible products.

If greater adhesion is required, the evaluation of primer SS4044 (clear) is recommended. SS4044 is listed with the USDA.

The final granting of authorization for the proposed use of such sealants is the responsibility of the inspector in charge of the official plant. Technical assistance will be provided by the Product Safety Branch of USDA upon request. These sealants are found in the "List of Proprietary Substances and Nonfood Compounds" issued by USDA. A copy of the approval letter may be required by the USDA inspector. A copy of the approval letter may be obtained from the Momentive Product Regulatory Compliance Operation.

## NSF STATUS

The National Sanitation Foundation lists **RTV102, RTV103, RTV106, RTV108, RTV109, RTV112, RTV116, RTV118, IS802, IS803, IS806** and **IS808** sealants under NSF Standard No. 51 "Plastic Materials and Components for Use in Food Equipment" as satisfactory for use on food contact surfaces. If greater adhesion is required, the evaluation of SS4044 primer is recommended. SS4044, is also listed under NSF Standard No. 51.

## PRODUCT DATA

Product data sheets describing specific product properties, typical industrial applications and instructions for use are available from Momentive Performance Materials. Call the Momentive sales office nearest you, or an authorized Momentive product distributor. You can visit our website at [www.momentive.com](http://www.momentive.com)

## Standard Methyl Silicone Chemical Resistance

	Chemical	Volume Change
Acid	Concentrated Hydrochloric Acid	+
	Hydrochloric Acid (3%)	+
	Concentrated Sulphuric Acid	Decomposition
	Sulphuric Acid (10%)	+
	Concentrated Nitric Acid	△
	Nitric Acid (7%)	+
	Glacial Acetic Acid	+
	Acetic Acid	+
	Hydrofluoric Acid	Decomposition
	Citric Acid	+
Alkali	Phosphoric Acid	+
	Concentrated Ammonia	+
	Ammonia (10%)	+
	Potassium Hydroxide (20%)	+
	Sodium Hydroxide (1%)	+
	Sodium Hydroxide (20%)	+
Inorganic Saline Solution	Sodium Hydroxide (50%)	+
	Sodium Chloride (10%)	+
	Sodium Carbonate (2%)	+
	Sodium Carbonate (20%)	+
	Hydrogen Peroxide (3%)	+
	ASTM No. 1 Oil (150°C, 70h)	+
Oil	ASTM No. 3 Oil (150°C, 70h)	△
	Mineral Oil	+
	Castor Oil	+
	Flax Seed Oil	+
	Silicone Oil (35°C, 70h)	△
Solvent <sup>(1)</sup>	Acetone	△
	Butyl Alcohol	O
	Ethyl Alcohol	+
	Gasoline	X
Water	Mineral Spirit	X
	Toluene	X
	Water (room temperature)	+
	Boiling Water (70h)	+

+ :<10%

O :10-25%

△ :25-75%

Test Method: Volume change of cured liquid silicone rubber after immersion time of 1 week at 25°C.

(1) Suggest the evaluation of Momentive fluorosilicones for solvent applications.



## FAQ's

### What does RTV mean?

RTV stands for Room Temperature Vulcanization. RTV silicones are products that cure (vulcanize) at room temperature although some need higher temperatures to cure. RTV silicones are thermoset products.

### What does thermoset mean?

Thermoset relates to products that cannot be transformed to their original form once cured. Once RTV silicones have cured (or vulcanized), they can not be transformed back into a paste to be recast.

### What is the cure mechanism of a condensation cure product?

Condensation cure silicone products cure when exposed to atmospheric moisture. Moisture in the air is generally required to cure (or vulcanize) condensation cure products. The cure process begins from the most exposed area of the product to air, to the least exposed area, thus time is required for complete cure. The cure time is affected by the reaction mechanism and viscosity of the material. Generally, at 25°C and 50%RH, condensation cure RTV silicones cure through in 24 to 48 hours. Full physical properties may take 7 to 14 days to develop (refer to product literature for specific cure rates).

### What are the byproducts for condensation cure RTV's?

For one-part condensation cure RTV's, the byproducts are: acetic acid (acetoxycure RTV's), alcohol (alkoxy cure RTV's) and methanol and/or ammonia (methoxy cure RTV's).

For two-part condensation cure RTV's, the byproducts are alcohol and water. Because condensation cure RTV's release byproducts during the cure process, it is recommended to cure the RTV in an open system to permit the byproduct to escape. This will enable the full properties of the material to develop and will reduce or eliminate any stability issues due to reversion.

### What is the depth (bead thickness) limitation for a condensation cure RTV?

For one-part, condensation cure RTV's, the depth (bead thickness) limitation is 1/4 inch. For two-part, condensation cure RTV's, the depth (bead thickness) limitation is 1 inch unless RTV9811 or STO is used in place of DBT.

### Can I accelerate the cure time of a one-part RTV silicone?

Condensation cure RTV silicone product cure rates depend on humidity, silicone thickness, and to a smaller degree heat. Increasing the relative humidity around the silicone or reducing the thickness of the material will reduce the time to cure the material. Increased heat (not over 50°C) will somewhat reduce cure time but, as mentioned, will do so to a much smaller degree than humidity or thickness.

### What is the cure mechanism of an addition cure product?

Addition cure silicone products cure when exposed to heat. Although some heat cure products can cure at room temperature, higher heat greatly accelerates the cure. One-part heat cure products typically have an inhibitor in the formulation which prevents the product from curing until an activation temperature, greater than room temperature, is achieved. The inhibitor is subsequently driven off and the cure reaction is allowed to proceed. Heat cure products do not liberate by-products during cure.

### What are the byproducts for addition cure RTV's?

Addition cure RTV's do not give off a byproduct.

### What do "pot life" and "work life" mean?

The amount of time after a two-part RTV is mixed with its curing agent that it will remain useful or pliable.

### What does "tack free time" mean?

Tack free time refers to the amount of time it takes for a condensation cure RTV silicone product to form a cured outer layer (the cured outer layer is not tacky like uncured material). Condensation cure products generally cure from the outside (or exposed surface(s)) inward because of the need for moisture in the air for the curing reaction. Tack free time is not applicable to addition cure RTV materials.

### What does thixotropic mean?

Thixotropy is the property that allows a paste-like material to flow under pressure or agitation (i.e. allows a paste to be dispensed from a caulk gun). Basically, a thixotropic material thins (reduces in viscosity) when shear forces are applied to it and then thickens again when the shear forces are removed.

### What does "flowable" (also called self-leveling) mean?

Flowable describes a material whose top surface when dispensed will self level. Typical RTV materials that are flowable will have the consistency of ketchup and some will even flow like honey.

### What is mix ratio and where is the mix ratio found?

Mix ratio is a term used to state the amount of each material to be in a multi-component material. The mix ratios for two-part RTV products are described on the individual product data sheets and are given as a ratio by weight of each material.

### How do I remove silicone?

**Before it is cured:** Use a putty knife to remove any of the uncured paste. Wipe the area clean with isopropyl alcohol to remove any leftover residue.

**After it is cured:** First you should mechanically remove as much of the silicone as you can with either a knife or a razor. A solvent can then be used to remove any oily residue or any remaining silicone, It may be necessary to soak the silicone in a solvent overnight to break it down. Below is a list of solvents in the order of aggressiveness in attacking the silicone:

- Paint thinner (mineral spirits)
- Toluene
- Xylene
- Acetone

### Can I thin a silicone?

Silicone can be thinned using a solvent in which the silicone is miscible, generally an aromatic solvent such as toluene or xylene. As always, be sure to follow the manufacturer's instructions when using solvent products and always use in a well-ventilated area. The shrinkage of the silicone and the cure time will increase with the addition of solvent. Alternative suggestions would include non-reactive fluids or an RTV with a lower viscosity.

### What type of release agents should I use if I don't want silicone to adhere to a substrate?

For small molds, a customer can use a dry Teflon spray or petroleum jelly as a release agent (dilute the petroleum jelly with hexane to make it easier to apply - 80% hexane to 20% petroleum jelly).

### How do I ensure that air is removed from two-part grades?

If you are hand mixing, air may become added to the material during the mixing process. Vacuum de-airing is most effective in removing air prior to use. Automated mixing equipment that utilizes a static mixer can eliminate the need to de-air prior to dispensing.

### Why use a Silicone vs. an organic compound such as an epoxy or urethane?

RTV silicones exhibit high performance under many harsh operating environments.

## Relative Performance Characteristics

Property	Silicone RTV	Epoxy	Urethane
Temperature Range	50 - 200°C	50 - 150°C	30 - 120°C
Heat Resistance	Excellent	Poor	Poor
Flame Retardency <sup>(1)</sup>	Excellent	None	None
UV Stability	Excellent	Poor	Poor
Ozone Stability	Excellent	Poor	Poor
Modulus	Low	High	High

(1) As a base material, silicone demonstrates flame retardant properties comparable to UL94HB. Refer to page 40 and 41 for information on UL recognized products.

### What is the Young's Modulus for silicone?

In rubber, modulus refers to the force per unit of original cross section to a specific extension. It is a ratio of the stress of rubber to the tensile strain but differs from that of metal, as it is not a Young's modulus stress-strain-type curve. Stress-strain values are extremely low for slight extensions but increase logarithmically with increased extension. Rubber has the useful property, for some products, of being extensible to 10 times its original length. The modulus can vary for the same hardness and does affect the stiffness of insulation. (Source: Handbook of Plastics, Elastomers, and Composites, 3rd Edition, Charles A Harper, McGraw-Hill.)

### What is cure inhibition?

Cure inhibition is a phenomenon that may be observed in addition cure grades. Addition cure products use a platinum catalyst to drive the curing reaction. Inhibition can be prevented by the application of a barrier coat, cleaning the inhibiting material prior to application of the addition cure silicone, replacing the inhibiting material with a more suitable alternative, or selecting a condensation cure RTV.

### Indicators: Interface between the silicone and substrate will appear "gummy/sticky" and/or incomplete cure attained.

### Typical contaminants include, but are not limited to:

- Sulfur, Sulfides (common example: Latex gloves)
- Amines
- Tin-fatty acids, Tin salts and Tin soaps
- Some clays
- Natural rubber
- Neoprene rubber
- Petroleum jelly
- Phosphorus-phosphines, phosphites
- Nitrogen-amines, amides, nitriles, cyanates
- Arsenic-arsines
- Compounds with unsaturated bonds
- Alcohols-ethanol, methanol
- Esters-ethyl acetate, vinyl acetate
- Substrates containing plasticizers, anti-slip additives, stabilizers
- Substrates with coatings containing calcium carbonate, polyvinyl acetate, acrylic latex, natural rubber latex
- Alginates



Product Selector Guide: Condensation Cure and Addition Cure Adhesives and Sealants

Type	Grade	Cure Chemistry	Cured Property	Features	PERFORMANCE							Product Detail	
					Flowability	UL Recognition	Low Volatility	High Temperature Resistance	Low Temperature Resistance	FDA Compliant	Thermally Conductive		Military Specification
One Part Condensation Cure	ECC3050S	Heat	Rubber	Low temperature curing, low viscosity coating	Flowable	UL listed							P. 10
	FRV1106	Acetoxy	Rubber	Fuel, solvent, chemical resistant Fluoro sealant	Non-flowable								P. 9
	IS800 series <sup>(1)</sup>	Acetoxy	Rubber	General purpose paste adhesive	Non-flowable	UL94 HB				•			P. 9
	IS806	Acetoxy	Rubber	Temperature resistant paste adhesive	Non-flowable	UL94 HB		•		•			P. 9
	IS902	Modified Alkoxy	Rubber	Paintable adhesive	Non-flowable								P. 13
	RTV100 series	Acetoxy	Rubber	High performance, paste adhesive	Non-flowable	UL listed				•		MIL-A-46106B	P. 8
	RTV106	Acetoxy	Rubber	Temperature resistant paste adhesive	Non-flowable	UL listed		•		•		MIL-A-46106B	P. 8
	RTV112	Acetoxy	Rubber	High performance, self-leveling sealant	Flowable	UL listed				•		MIL-A-46106B	P. 8
	RTV116	Acetoxy	Rubber	High performance, self-leveling sealant	Flowable	UL listed				•		MIL-A-46106B	P. 8
	RTV118	Acetoxy	Rubber	Temperature resistant flowable sealant	Flowable	UL listed		•		•		MIL-A-46106B	P. 8
	RTV120 series	Modified Alkoxy	Rubber	Paste adhesive	Non-flowable	UL94 HB						MIL-A-46146B	P. 13
	RTV133	Alkoxy	Rubber	Paste sealant	Non-flowable	UL94 V-0/V-1							P. 10
	RTV142	Alkoxy	Rubber	Low volatile, paste adhesive	Non-flowable			•					P. 11
	RTV1473	Acetoxy	Rubber	Oil resistant, paste adhesive	Non-flowable								P. 9
	RTV157	Acetoxy	Rubber	High strength sealant	Non-flowable								P. 8
	RTV159	Acetoxy	Rubber	High strength sealant	Non-flowable					•			P. 9
	RTV160	Alkoxy	Rubber	Non-corrosive coating	Flowable	UL94 HB							P. 10
	RTV162	Alkoxy	Rubber	High strength, non-corrosive adhesive	Non-flowable	UL94 HB						MIL-A-46146B	P. 10
	RTV167	Alkoxy	Rubber	High strength, non-corrosive adhesive	Non-flowable	UL94 HB						MIL-A-46146B	P. 10
	RTV1673LV	Modified Alkoxy	Rubber	Low volatile, non-corrosive paste adhesive	Non-flowable			•					P. 12
	RTV5220 series	Alkoxy	Rubber	Low modulus, paste adhesive	Non-flowable	UL94 HB							P. 10
	RTV5240 series	Alkoxy	Rubber	Hydrolytically stable, paste adhesive	Non-flowable	UL94 HB							P. 11
	RTF5308	Modified Alkoxy	Rubber	Fast curing, paste adhesive	Non-flowable								P. 12
	RTV5810 series	Modified Alkoxy	Rubber	Fast curing, paste adhesive	Non-flowable	UL94 HB							P. 13
	RTV6700 series	Modified Alkoxy	Rubber	Paste adhesive; UL recognized	Non-flowable	UL94 HB							P. 12
	Oxime series	Oxime	Rubber	General purpose and high temperature performing options	Flowable, non-flowable options	Various				•			P. 14-15
	TSE392	Alkoxy	Rubber	Fast tack, non-corrosive adhesive	Non-flowable	UL94 HB							P. 11
	TSE397	Alkoxy	Rubber	Non-corrosive, flowable adhesive	Flowable	UL94 HB							P. 11
TSE399	Alkoxy	Rubber	Non-corrosive pourable adhesive / coating	Flowable								P. 11	
TSE3991	Alkoxy	Rubber	Low viscosity variant of TSE399	Flowable								P. 11	
Two Part Condensation Cure	RTV11	Alkoxy	Rubber	General purpose, potting sealant	Flowable					•			P. 18
	RTV12	Alkoxy	Rubber	Low viscosity, general purpose coating	Flowable								P. 18
	SnapSil* series	Alkoxy	Rubber	Fast cure/property build	Non-flowable	UL94 HB							P. 16
	RTV200 series	Alkoxy	Rubber	Fast cure, high strength paste adhesive	Flowable								P. 16
	RTV21	Alkoxy	Rubber	General purpose, potting sealant	Flowable								P. 18
	RTV31	Alkoxy	Rubber	High temperature resistant, flowable sealant	Flowable					•			P. 16
	RTV41	Alkoxy	Rubber	General purpose, potting sealant	Flowable						•		P. 18
	RTV511	Alkoxy	Rubber	Low temperature, flowable sealant	Flowable						•		P. 17
	RTV560	Alkoxy	Rubber	Low and high temperature resistant, flowable sealant	Flowable					•	•		P. 17
	RTV566	Alkoxy	Rubber	Low volatile, low and high temperature resistant flowable sealant	Flowable			•		•	•		P. 17
	RTV567	Alkoxy	Rubber	Low volatile, low temperature resistant flowable sealant	Flowable			•			•		P. 17
	RTV577	Alkoxy	Rubber	Low temperature, paste sealant	Non-flowable						•		P. 17
	RTV60	Alkoxy	Rubber	High temperature resistant, flowable sealant	Flowable					•			P. 16
	RTV8111	Alkoxy	Rubber	General purpose, potting sealant	Flowable							MIL-PRF-23586F	P. 18
	RTV8112	Alkoxy	Rubber	General purpose, potting sealant	Flowable							MIL-PRF-23586F	P. 18
	RTV8262	Alkoxy	Rubber	High temperature resistant, flowable sealant	Flowable					•		MIL-PRF-23586F	P. 16
	RTV88	Alkoxy	Rubber	High temperature resistant, spreadable paste sealant	Non-flowable					•			P. 17
	RTV88HB	Alkoxy	Rubber	High temperature resistant, spreadable paste sealant	Non-flowable					•			P. 17
	TSE3664	Alkoxy	Rubber	Fast cure, low viscosity adhesive	Flowable	UL94 V-0							P. 16
	One Part Addition Cure	ECC4865	Heat	Rubber	Low viscosity coating	Flowable	UL listed						
RTV6424		Heat	Rubber	Fast cure at elevated temperatures; Paste adhesive	Non-flowable								P. 20
TSE322		Heat	Rubber	Non-corrosive adhesive	Non-flowable	UL94 HB							P. 21
TSE3251		Heat	Rubber	Non-corrosive coating	Flowable								P. 20
TSE326		Heat	Rubber	High temperature resistant adhesive	Flowable	UL94 HB				•			P. 21
Two Part Addition Cure	RTV615	Heat	Rubber	High strength with optical clarity	Flowable						•		P. 22
	RTV627	Heat	Rubber	Fast curing sealant	Flowable	UL94 V-0/V-1							P. 23
	RTV6428	Heat	Rubber	Fast cure at low temperature	Flowable	UL94 V-0/V-1							P. 23
	RTV655	Heat	Rubber	Low temperature resistant potting compound	Flowable						•		P. 22
	RTV656	Heat	Rubber	Low temperature resistant potting compound	Flowable						•		P. 22
FRV138	Heat	Rubber	Fuel, solvent, chemical resistant encapsulant	Flowable								P. 23	

(1) IS802 does not currently meet with FDA regulation 21CFR177.2600 "Rubber Articles Intended for Repeated Use."

Product Selector Guide: Catalyst Options

Type	Grade	Features	Product Detail
Paste Catalysts	DBT	Standard curing agent; Moderate speed	P. 19
	RTV9811	Deep section cure; paste version of DBT	P. 19
	RTV9858	Paste version of DBT; used in 5% to 7%	P. 19
	RTV9891	Fast curing, paste version of STO	P. 19
	RTV9910	Paste version of DBT (0.1%)	P. 19
	RTV9950	Paste version of DBT (0.5%)	P. 19
	STO	Fast cure speed	P. 19

Product Selector Guide: Thermally Conductive Adhesives and Sealants

Type	Grade	Cure Chemistry	Features	Performance				Product Detail
				Flowability	UL Recognition	Low Volatility	Thermally Conductive	
Thermally Conductive	SilCool* LTR3292	Heat	Thin bond line capable, flowable adhesive	Flowable			•	P. 24
	SilCool* LTR3295	Heat	Thin bond line capable, fast curing, flowable adhesive	Flowable			•	P. 24
	TSE3080	Heat	Thermally conductive potting gel	Flowable			•	P. 25
	TSE3280-G	Heat	Adhesive for thermal conductive applications	Flowable			•	P. 25
	TSE3281-G	Heat	Adhesive for thermal conductive applications	Flowable			•	P. 25
	TSE3331	Heat	Thermally conductive adhesive	Flowable	UL94 V-0		•	P. 25
	TSE3941	Condensation	Paste adhesive	Non-flowable	UL94 V-1		•	P. 24
	XE11-B5320	Condensation	Low volatile paste adhesive	Non-flowable			•	P. 24

Product Selector Guide: Greases

Type	Grade	Features	Performance		Product Detail
			Thermally Conductive	Low Volatility	
Greases	SilCool* TIG2000	High thermal conductivity	•		P. 26
	YG6260	Moderate thermal conductivity	•	•	P. 26

Product Selector Guide: Semiconductor Die-Attach Adhesives and Sealants

Type	Grade	Cure Chemistry	Cured Property	Features	Performance				Product Detail
					Flowability	Junction Resin Coating (JCR)	Electro-Conductive	Thermally Conductive	
Semiconductor Die-Attach Adhesives and Sealants	CRTV5120	Acetoxy (Condensation)	Rubber	Semi-conductive paste adhesive	Non-flowable		•		P. 26
	SilFas* SDC5000	Addition	Rubber	Electrically conductive paste adhesive	Non-flowable		•	•	P. 26
	XE5844	Addition	Rubber	Translucent JCR-grade with high refractive index	Flowable	•			P. 26

Product Selector Guide: Gels

Type	Grade	Cure Chemistry	Cured Property	Features	Performance			Product Detail
					Flowability	UL Recognition	Low Temperature Resistance	
Gels	RTV6100A	Heat / Room temperature cure capable	Gel	Additive for RTV61XX series	Flowable			P. 28
	RTV6136	Heat / Room temperature cure capable	Gel	High strength, fast cure, tough gel	Flowable			P. 28
	RTV6156	Heat / Room temperature cure capable	Gel	Low temperature resistant gel	Flowable		•	P. 28
	RTV6166	Heat / Room temperature cure capable	Gel	General purpose gel	Flowable			P. 28
	RTV6186	Heat	Gel	Fast cure, tough gel with extended pot life	Flowable			P. 29
	RTV6196	Heat / Room temperature cure capable	Gel	Fast cure, low viscosity gel	Flowable			P. 29
	TSE3051	Heat	Gel	One-part, fast cure gel	Flowable			P. 29
	TSE3051FR	Heat	Gel	One-part, fast cure gel	Flowable	UL94 V-1		P. 29
	TSE3070	Heat / Room temperature cure capable	Gel	High elongation gel	Flowable			P. 29

Product Selector Guide: InvisiSil\* LED and Optoelectronics Encapsulants

Type	Grade	Cure Chemistry	Cured Property	Features	Performance		Product Detail
					Flowability	Product Detail	
InvisiSil LED and Optoelectronics Encapsulants	IVS4012	Heat	Gel	Optically clear gel	Flowable		P. 30
	IVS4312	Heat	Rubber	Optically clear elastomer	Flowable		P. 30
	IVS4632	Heat	Rubber	Optically clear elastomer	Flowable		P. 30
	IVS5022	Heat	Gel	Optically clear gel	Flowable		P. 30
	IVS5332	Heat	Rubber	Optically clear elastomer	Flowable		P. 30
	IVSM4500	Heat	Rubber	Optically clear, hard elastomer	Flowable		P. 30

Product Selector Guide: Silicone Liquid Elastomers (SLEs)

Type	Grade	Cure Chemistry	Cured Property	Features	Performance		Product Detail
					Flowability	FDA Recognition	
Silicone Liquid Elastomers	SLE5500	Heat	Rubber	High viscosity, low durometer	Flowable	•	P. 30
	SLE5401	Heat	Rubber	Excellent adhesion to synthetic fibers	Flowable		P. 30
	SLE5600	Heat	Rubber	High strength and abrasion resistance	Semi-flowable	•	P. 30
	SLE5700	Heat	Rubber	Enhances physical strength of engineered textiles	Flowable		P. 31
	SLE7000	Heat	Rubber	Rapid cure in thin films	Semi-flowable		P. 31

Product Selector Guide: Foams

Type	Grade	Cure Chemistry	Cured Property	Features	Performance		Product Detail
					Flowability	UL Recognition	
Foams	RTF7000	Condensation	Foam	Variable foam densities	Flowable		P. 32
	RTF762	Condensation	Foam	Medium density foam	Flowable	UL94 V-0	P. 32
	RTF8510	Condensation	Foam	Medium density foam	Flowable		P. 33
	RTF5308	Condensation	Rubber / Foam	Expandable Silicone Foam per GM2224M2D2CF1, Type II	Flowable		P. 33

Product Selector Guide: Primers

Type	Grade	Features	FDA Recognition	Product Detail
Primers	SS4004P	General purpose		P. 39
	SS4044P	Transparent general purpose; FDA compliant	•	P. 39
	SS4120	Transparent; For use with addition cure RTVs; FDA compliant	•	P. 39
	SS4155	General purpose		P. 39
	SS4179	Transparent; For use with difficult-to-bond to plastic substrates; FDA compliant	•	P. 39

Product Selector Guide: Mold Making Grades and Accessories

Type	Grade	Cure Chemistry	Cured Property	Features	Performance			FDA Recognition	Product Detail
					Flowability	Color	Catalysts Options		
Mold Making Grades and Accessories	RTV421	Condensation	Rubber	Low durometer; Excellent resistance to polyurethane resins	Flowable	Pink			P. 34
	RTV426	Condensation	Rubber	Flexible catalyst system; Excellent resistance to polyurethane resins	Flowable	Green	•		P. 34
	RTV430	Condensation	Rubber	Flexible catalyst system; High durometer	Flowable	Pink / Lt. Blue	•		P. 34
	RTV630	Heat curable	Rubber	High tear resistance; Excellent durability	Semi-flowable	Blue			P. 36
	RTV662	Heat curable	Rubber	Highest durometer and long work life	Semi-flowable	Blue			P. 36
	RTV664	Heat curable	Rubber	High durometer and good dimensional stability; FDA compliant	Semi-flowable	Blue		•	P. 36
	RTV668	Heat curable	Rubber	High durometer and good dimensional stability	Flowable	Blue			P. 36
	RTV7888-20	Condensation	Rubber	Flexible catalyst system; Medium durometer; Excellent resistance to polyester	Flowable	Pink / White	•		P. 35
	TSE3453T	Heat curable	Rubber	Translucent; Low durometer; Good resistance to urethanes	Flowable	Translucent			P. 37
	TSE3455T	Heat curable	Rubber	Lowest viscosity; Excellent resistance to polyurethane	Flowable	Translucent			P. 37
	TSE3457T	Heat curable	Rubber	Medium durometer; Good dimensional stability	Flowable	Translucent			P. 37
	TSE3466	Heat curable	Rubber	High durometer, low viscosity	Flowable	Translucent			P. 37
	BETA 5	Catalyst	-	High temperature resistant	Flowable	Red			P. 34
	BETA 11-D1	Catalyst	-	General use	Flowable	Blue			P. 34
	BETA 16	Catalyst	-	Generally suitable for use with sulfur-based clays	Flowable	Red			P. 34
	BETA 17	Catalyst	-	Generally suitable for use with sulfur-based clays	Flowable	Translucent			P. 34
	BETA 18	Catalyst	-	Generally suitable for use with sulfur-based clays	Flowable	Red			P. 34
	BETA 26	Catalyst	-	Designed for polyurethane casting resins	Flowable	Green			P. 34
	SF1188A	Fluid	-	Thixotropic agent	Flowable	Clear to Straw			P. 35
	SF97-50	Fluid	-	Dilutant	Flowable	Translucent			P. 35

# What Momentive Can Do For You

Momentive Performance Materials can help customers increase performance, troubleshoot product development issues, and engineer better manufacturing processes. Our unique adhesives, sealants, and specialty RTV silicone rubbers are the starting point for new and creative ideas across hundreds of commercial and consumer applications such as appliances, aviation and aerospace, automotive, electronics and healthcare applications. Our materials and enabling technologies are at the frontline of innovation.

A few of the benefits of working with Momentive Performance Materials are:

- Technical Service**  
 Product and equipment suggestions  
 Troubleshooting  
 Customer training
- Field Technical Support of Trials, Start-ups and Troubleshooting Application Problems**  
 Commercialized products  
 Experimental products
- Application Development/Customer Center**  
 Product development  
 Application design and support
- Custom Facility in Garrett, Indiana**  
 Momentive Performance Materials offers the capability to customize select, addition cure RTV products. Properties such as durometer, color/appearance, work life, and packaging types can be modified to meet your specific application needs.  
  
 By tailoring product performance and/or packaging type, Momentive provides you the design freedom and manufacturing flexibility to be more innovative and competitive. For more information on the RTV Customization program, please contact your Area Sales Representative.
- Samples Readily Available for Many of the Products Offered in Our Portfolio**  
 Please contact our Technical Service center at 800.295.2392 or your Area Sales Representative for additional information.

Call us today at 800.295.2392 or +607.786.8131 to discuss how we can put our materials and technology to work for you, or visit our website at [www.momentive.com](http://www.momentive.com).

**Patent Status**

Nothing contained herein shall be construed to imply the nonexistence of any relevant patents or to constitute the permission, inducement or recommendation to practice any invention covered by any patent, without authority from the owner of the patent.

## CUSTOMER SERVICE CENTERS

---

<b>North America</b>	<b>E cs-na.silicones@momentive.com</b>		
	<ul style="list-style-type: none"><li>Specialty Fluids</li><li>UA, Silanes, Resins and Specialties</li><li>RTV Products-Elastomers</li><li>Sealants and Adhesives &amp; Construction</li></ul>	T +1.800.523.5862 T +1.800.334.4674 T +1.800.332.3390 T +1.877.943.7325	F +1.304.746.1654 F +1.304.746.1623 F +1.304.746.1623 F +1.304.746.1654
<b>Latin America</b>	<b>E cs-la.silicones@momentive.com</b>		
	<ul style="list-style-type: none"><li>Argentina &amp; Chile</li><li>Brazil</li><li>Mexico &amp; Central America</li><li>Venezuela, Ecuador, Peru Colombia &amp; Caribbean</li></ul>	T +54.11.4862.9544 T +55.11.4534.9650 T +52.55.5899.5135 T +58.212.285.2149	F +54.11.4862.9544 F +55.11.4534.9660 F +52.55.5899.5138 F +58.212.285.2149
<b>Europe, Middle East, Africa and India</b>	<b>E cs-eur.silicones@momentive.com</b>	T +00.800.4321.1000 T +31.164.225350	
<b>Pacific</b>	<b>E cs-ap.silicones@momentive.com</b>	T +0120.975.400 T +0.81.276.20.6182	F +81.276.31.6259
<b>Worldwide Hotline</b>		T +1.607.786.8131 T +1.800.295.2392	F +1.607.786.8309

**Visit us at [Momentive.com](http://Momentive.com)**

---

THE MATERIALS, PRODUCTS AND SERVICES OF MOMENTIVE PERFORMANCE MATERIALS INC., MOMENTIVE PERFORMANCE MATERIALS USA INC., MOMENTIVE PERFORMANCE MATERIALS ASIA PACIFIC PTE. LTD., MOMENTIVE PERFORMANCE MATERIALS WORLDWIDE INC., MOMENTIVE PERFORMANCE MATERIALS GmbH, MOMENTIVE PERFORMANCE MATERIALS SUISSE Sarl, THEIR SUBSIDIARIES AND AFFILIATES DOING BUSINESS IN LOCAL JURISDICTIONS (collectively "SUPPLIERS"), ARE SOLD BY THE RESPECTIVE LEGAL ENTITY OF THE SUPPLIER SUBJECT TO SUPPLIERS' STANDARD CONDITIONS OF SALE, WHICH ARE INCLUDED IN THE APPLICABLE DISTRIBUTOR OR OTHER SALES AGREEMENT, PRINTED ON THE BACK OF ORDER ACKNOWLEDGMENTS AND INVOICES, AND AVAILABLE UPON REQUEST. ALTHOUGH ANY INFORMATION, RECOMMENDATIONS, OR ADVICE CONTAINED HEREIN IS GIVEN IN GOOD FAITH, SUPPLIERS MAKE NO WARRANTY OR GUARANTEE, EXPRESS OR IMPLIED, (i) THAT THE RESULTS DESCRIBED HEREIN WILL BE OBTAINED UNDER END-USE CONDITIONS, OR (ii) AS TO THE EFFECTIVENESS OR SAFETY OF ANY DESIGN INCORPORATING SUPPLIERS' PRODUCTS, MATERIALS, SERVICES, RECOMMENDATIONS OR ADVICE. AFOREMENTIONED EXCLUSIONS OR LIMITATION OF LIABILITY ARE NOT APPLICABLE TO THE EXTENT THAT THE END-USE CONDITIONS AND/OR INCORPORATION CONDITIONS CORRESPOND TO THE RECOMMENDED CONDITIONS OF USE AND/OR OF INCORPORATION AS DESCRIBED BY SUPPLIER IN ITS PRODUCT DATA SHEET AND/OR PRODUCT SPECIFICATIONS. EXCEPT AS PROVIDED IN SUPPLIERS' STANDARD CONDITIONS OF SALE, SUPPLIERS AND THEIR REPRESENTATIVES SHALL IN NO EVENT BE RESPONSIBLE FOR ANY LOSS RESULTING FROM ANY USE OF ITS MATERIALS, PRODUCTS OR SERVICES DESCRIBED HEREIN.

Each user bears full responsibility for making its own determination as to the suitability of Suppliers' materials, services, recommendations, or advice for its own particular use. Each user must identify and perform all tests and analyses necessary to assure that its finished parts incorporating Suppliers' products, materials, or services will be safe and suitable for use under end-use conditions. Nothing in this or any other document, nor any oral recommendation or advice, shall be deemed to alter, vary, supersede, or waive any provision of Suppliers' Standard Conditions of Sale or this Disclaimer, unless any such modification is specifically agreed to in a writing signed by Suppliers. No statement contained herein concerning a possible or suggested use of any material, product, service or design is intended, or should be construed, to grant any license under any patent or other intellectual property right of Suppliers or any of its subsidiaries or affiliates covering such use or design, or as a recommendation for the use of such material, product, service or design in the infringement of any patent or other intellectual property right.

Copyright 2003-2008 Momentive Performance Materials Inc. All rights reserved.

\*InvisiSil, SilCool, SilFas and SnapSil are trademarks of Momentive Performance Materials Inc.

143-020-00E-GL  
02/08